

Wireless Data Acquisition System Hardware System Setting Software

MODEL: WDS-WIN01

Instruction Manual

[Web version]

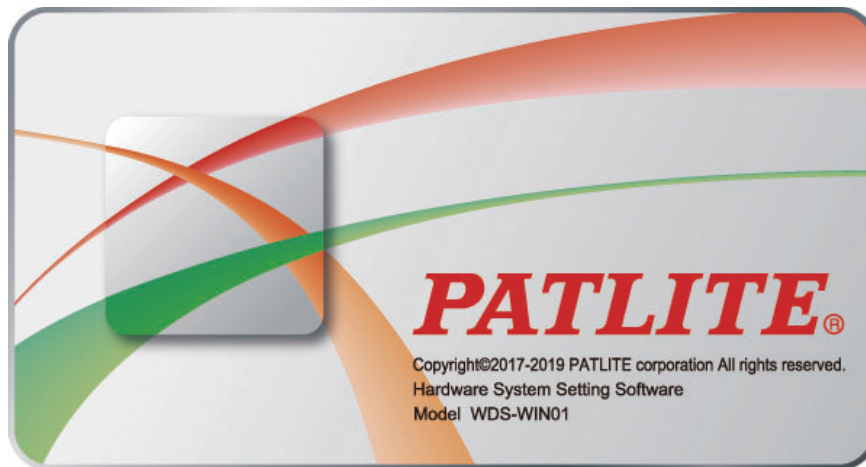

■ Notice to Customer

Thank for your using our PATLITE products.

The WDS-WIN01 hardware system setting software (hereafter referred to as "this product") is intended exclusively for the WD-Z2 and WD PRO Series Wireless Data Acquisition System.

- This manual describes the functions supported in Version 1.04. Depending on the version you use, some functions are not supported or screen layouts are different. We recommend the latest version which supports all functions.
- Before using this product, check the manual to see if your signal tower model is supported.
- Review the Software License Agreement before using this product.
- To ensure correct use, read this manual thoroughly prior to installation. Read this manual together with [WDT- □ LR-Z2/WDR-L(E)-Z2 Instruction Manual].
- Re-read this manual before conducting maintenance, inspections, and repairs. If there are any questions concerning this product, refer to the contact information at the end of this document and contact your nearest PATLITE Sales Representative.

■ To the Contractor

- Before installing, read this manual carefully to ensure correct installation.
- Return this manual to the customer.

■ Table of Contents

1	Before you begin	5
1.1	About Safety Symbols	5
1.2	Safety Precautions	6
2	Overview	8
2.1	About this product	8
2.2	About Models	8
2.3	System Configuration.....	9
2.4	Operation Environment.....	12
2.5	About license authentication	13
3	Functions: Overview.....	14
3.1	Function Table.....	14
3.2	Operation screen layout: Overview.....	14
4	Operation guidelines	16
4.1	Using WDS-WIN01 for the first time	16
4.2	Setting up the WDT and WDR.....	16
4.3	Checking the WDT and WDR communication status	17
4.4	Running data collection.....	17
4.5	Export or import data collection settings information	18
4.6	Import WDS-AUTO2 user name information	18
4.7	Uninstall WDS-WIN01.....	18
5	Installation	19
5.1	Installing.....	19
5.2	Uninstalling	25
5.3	Starting WDS-WIN01	27
5.4	Exiting WDS-WIN01.....	28
5.5	Changing the display language.....	29
6	Operation.....	31
6.1	WDT/WDR settings.....	31
6.1.1	WDR network settings	31
6.1.2	WDT setup.....	41
6.1.3	WDR setup	48
6.1.4	Configure WDR Host Collaboration Function (WD PRO receiver only)	51
6.2	Data collection	54
6.2.1	License authentication.....	54
6.2.2	Data save destination and CSV file format settings	55
6.2.3	Save WDT user name	59
6.2.4	Registering WDR and starting collection	61

6.2.5	Checking the data save destination.....	64
6.2.6	Checking communication status of WDT while collecting data	65
6.2.7	Stopping data collection	66
6.2.8	Save settings and return.....	68
6.3	Exporting and importing settings information.....	73
6.3.1	Exporting settings information	73
6.3.2	Importing settings information	74
6.4	Obtaining WDT user names for WDS-AUTO2	75
6.5	Check WDT and WDR settings.....	77
6.6	Confirm WDT connection using WDT ping	80
6.7	Clear Counter value	82
7	List of Settings.....	84
7.1	WDT/WDR settings.....	84
7.1.1	WDT settings	84
7.1.2	WDR settings (computer connection settings)	92
7.1.3	WDR settings (Wireless settings).....	96
7.2	Data collection	98
7.2.1	Initial settings (save as CSV file).....	98
7.2.2	Initial settings (Save WDT user name).....	103
7.2.3	Initial settings (Data collection method).....	104
7.2.4	Data collection	106
7.2.5	Transfer WDS-WIN01 information	108
7.3	List of initial values.....	109
7.3.1	WDT/WDR settings	109
7.3.2	Data collection	111
8	Specifications	112
8.1	Software specifications	112
8.2	CSV file specifications	113
8.2.1	CSV file format	113
8.2.2	CSV file name.....	113
8.2.3	Define information in CSV file output.....	115
8.2.4	Example CSV file output.....	117
8.2.5	About creating and dividing CSV files.....	118
8.2.6	Example of CSV file division.....	118
8.2.7	Signal Tower Information Output When Dividing Files	120
9	Troubleshooting.....	121
9.1	Troubleshooting	121
9.2	Error messages.....	124

◆ About Trademarks and Registered Trademarks



- Windows[®], Microsoft[®], and Internet Explorer[®] are trademarks or registered trademarks of Microsoft Corporation in the United States and/or other countries.
- Intel[®], Intel Core[™] are trademarks of Intel Corporation in the United States and/or other countries.
- Xport[®] and Web manager are registered trademarks or trademarks of LANTRONIX Corporation in the United States.
- Company names and product names described in this document are trademarks or registered trademarks of those respective companies.

1 Before you begin



1.1 About Safety Symbols

To prevent injuries and product damage, note the following:



- ◆ The following symbols classify warnings and cautions, and describe the level of harm and damage that will occur when the corresponding instructions are not followed properly.



 WARNING	This symbol indicates, "Failure to follow the instructions may lead to death or serious injury."
 CAUTION	This symbol indicates, "Failure to follow the instructions may lead to injury or property damage."

- ◆ The following symbols classify and describe the content of associated messages.

 Prohibited	This symbol indicates "Prohibited" operations that should never be carried out.
 Mandatory	This symbol indicates "Mandatory" instructions that should always be carried out.
	This symbol indicates general "Caution" related information.

1.2 Safety Precautions

 WARNING	
 Prohibited	<ul style="list-style-type: none"> ◆ The wireless data acquisition system (hereafter referred to as "this system"), attaches to existing machinery and equipment. This system works with signal towers and sends changes in the operation status of signal towers via a wireless transmitter to a receiver that collects the data. Do not use this system for any other purpose. ◆ To prevent accidents, do not use this system other than for its intended purpose and do not run operations or maintenance other than those described in this manual. ◆ This system is not intended for use in applications where life is at risk, such as medical equipment, atomic energy equipment and machinery, aviation and aerospace, transportation, and control of other equipment. If this system is used for these applications, we cannot be held responsible in the event of injury, death, or property damage.
 Mandatory	<ul style="list-style-type: none"> ◆ Turn off the power before installing any equipment or electric wiring. Failure to follow this instruction could result in electric shock. ◆ In places such as aircraft and hospitals, turn off each of these systems where usage of wireless devices is prohibited and where its radio waves affect surrounding equipment. ◆ We cannot foresee all circumstances concerning the handling and dangers associated with this system. Therefore, not every possible danger is indicated in this instruction manual. To prevent accidents when operating or maintaining each of these systems, in addition to the safety guidelines identified in the instructions of this manual, follow all general safety guidelines.

 CAUTION	
 Prohibited	<ul style="list-style-type: none"> ◆ Do not use this system in applications that require a high-degree of reliability or real-time performance. If there are communication problems, this product cannot retrieve accurate data. ◆ Do not use or store this system in the following locations. Failure to follow this instruction could result in a malfunction or product failure. <ul style="list-style-type: none"> • Environments with poor breathability and ventilation • Near equipment that generate strong electrical or strong magnetic fields • Places exposed to direct sunlight • Locations subject to shock and vibration • Near heating appliances • Environments where there is dust, iron powder, and so on • Places near fire or environments with high temperatures and humidity • Locations where the product may experience a drop • Locations exposed to salty sea air
 Mandatory	<ul style="list-style-type: none"> ◆ Inspect the operating environment thoroughly before installing this system.

	<ul style="list-style-type: none"> ◆ Although this system has a high level of security, there is the potential for third-parties to intercept communications as this product uses radio waves. ◆ When using this system, pay close attention to the following: <ul style="list-style-type: none"> · Due to the nature of radio waves, communication can be disabled even over insignificant distances as a result of noise or other environmental factors. · To prevent static shock, make sure your body is discharged of static electricity. (You can discharge static electricity by touching grounded metal objects.) ◆ About the Operating Environment <ul style="list-style-type: none"> · We have tested the system with existing computers in a normal operating environment. Depending on operating conditions such as the type of computer, peripheral devices, and other applications in use, there may be cases where this system will not run properly. ◆ Software copyrights are held by our company. <ul style="list-style-type: none"> · Do not use this software in other products, or duplicate or modify a portion or all the software without prior written permission. ◆ Disposing this product <ul style="list-style-type: none"> · When disposing of this product, follow the rules and regulations on how to handle recyclable materials as outlined in your community. ◆ About this manual <ul style="list-style-type: none"> · The contents of this manual are subject to change without notice. · Images in this manual are for illustration purposes only, and may differ from the actual product. Additionally, the illustration may hide parts of the product for ease of explanation. · This manual is copyrighted. No part of the manual, including drawings or technical information, can be copied or duplicated in any manner, without prior consent. · If you have any questions or need further information, contact your nearest PATLITE sales representative.
---	--

We cannot warrant against breakdowns caused by disassembling this product, natural disasters, or handling of this product that is contrary to any warnings or precautions. Avoid using this product in ways other than those described in this manual.

We cannot be held responsible for damages and injuries caused by failing to pay attention, or failing to follow precautions, during operation and maintenance.

2 Overview

2.1 About this product

This product (software) is for:

- setting up WDT and WDR
- collecting signal tower information and saving it as CSV data

using the CSV data with visualization application software

2.2 About Models

(1) Model

WDS-WIN01

(2) WDR, WDT and WDB models

Type	Model
WDR	WDR-L-Z2
	WDR-LE-Z2
WD PRO Receiver	WDR-L-Z2-PRO
	WDR-L-Z2-PRO-L
	WDR-LE-Z2-PRO
	WDR-LE-Z2-PRO-L
	WDR-LE-Z2-PRO-L
WDT	WDT-5E-Z2
	WDT-6M-Z2
	WDT-4LR-Z2
	WDT-5LR-Z2
	WDT-6LR-Z2
	-PRO
WDB *	WDB-D80S-PRO

*Use only with WDT-PRO.

2.3 System Configuration

(1) System Configuration

① Run Time System Configuration

- Diagram

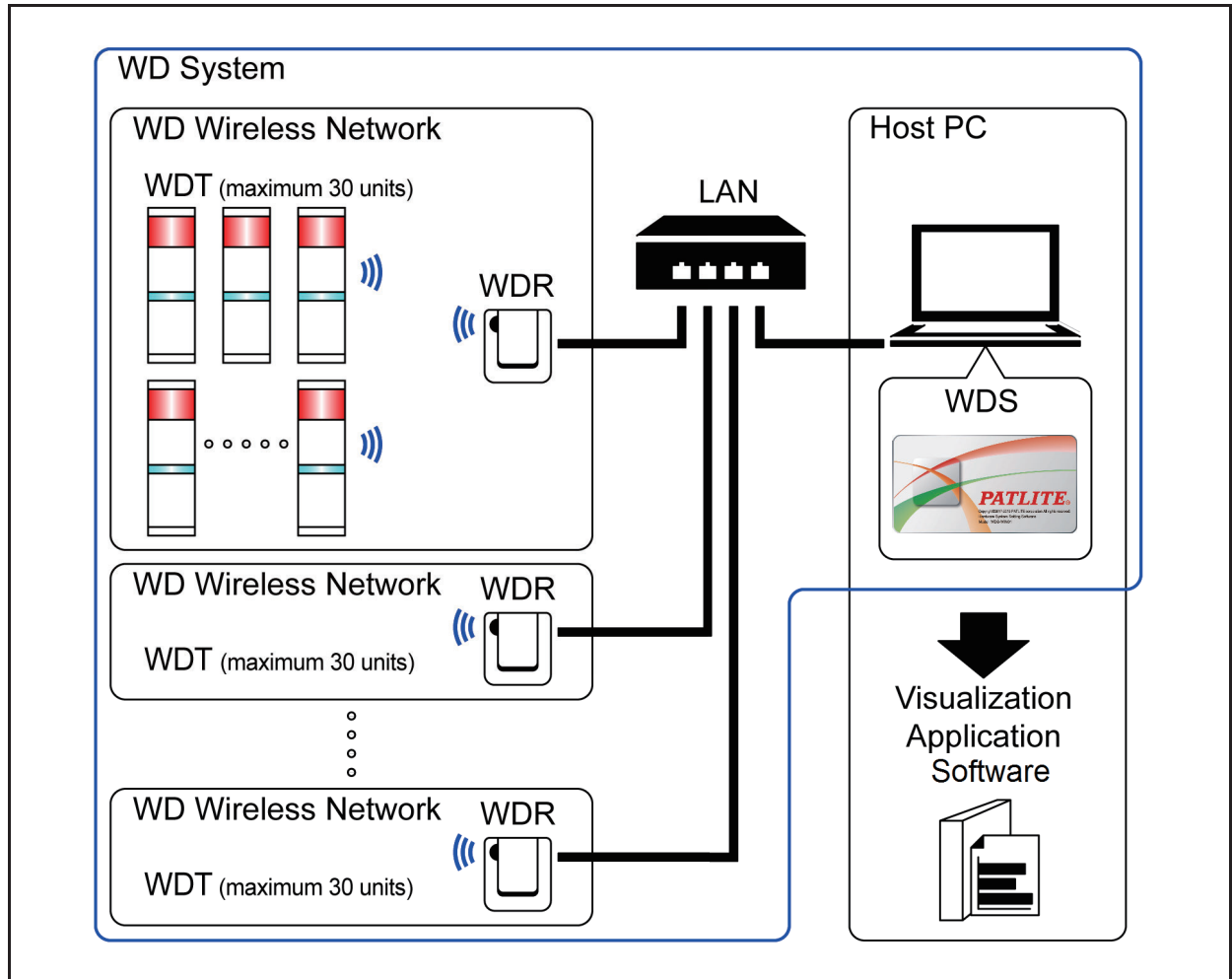

• Configuration

Item	Number of configuration items	Models
WDT	1 to 30 units*1 per receiver	WDT-4LR-Z2/WDT-5LR-Z2/WDT-6LR-Z2/ WDT-5E-Z2/WDT-6M-Z2/ WDT-6LR-Z2-PRO (WDB-D80S-PRO)
WDR	1 to 20 units	WDR-L-Z2/WDR-LE-Z2/ WDR-L-Z2-PRO/WDR-L-Z2-PRO-L/ WDR-LE-Z2-PRO/WDR-LE-Z2-PRO-L
WDS	1	WDS-WIN01 (this product)
Host PC*2	1 unit	–

*1. For more information, refer to  section 6.1.5 "How Many WDT you can connect to WDR" in the "[WDT- □ LR-Z2/WDR-L(E)-Z2 Instruction Manual]".

*2. When connecting the WDR directly to the host PC with a LAN cable, use a cross cable.

② Maintenance System Configuration

When performing maintenance, ensure that only 1 WDT and 1 WDR are connected at one time.

The following diagram shows a configuration example of the WDT-6LR-Z2 (using the WD System Setup Kit).

For information about the WDT system structure, refer to

 section 5.2.2.2 in the "[WDT- □ LR-Z2/WDR-L(E)-Z2 Instruction Manual]"

 section 5.2.2.2 in the "[WD PRO Series (WDB-D80S-PRO, WDT-6LR-Z2-PRO) Instruction Manual]"

• Diagram

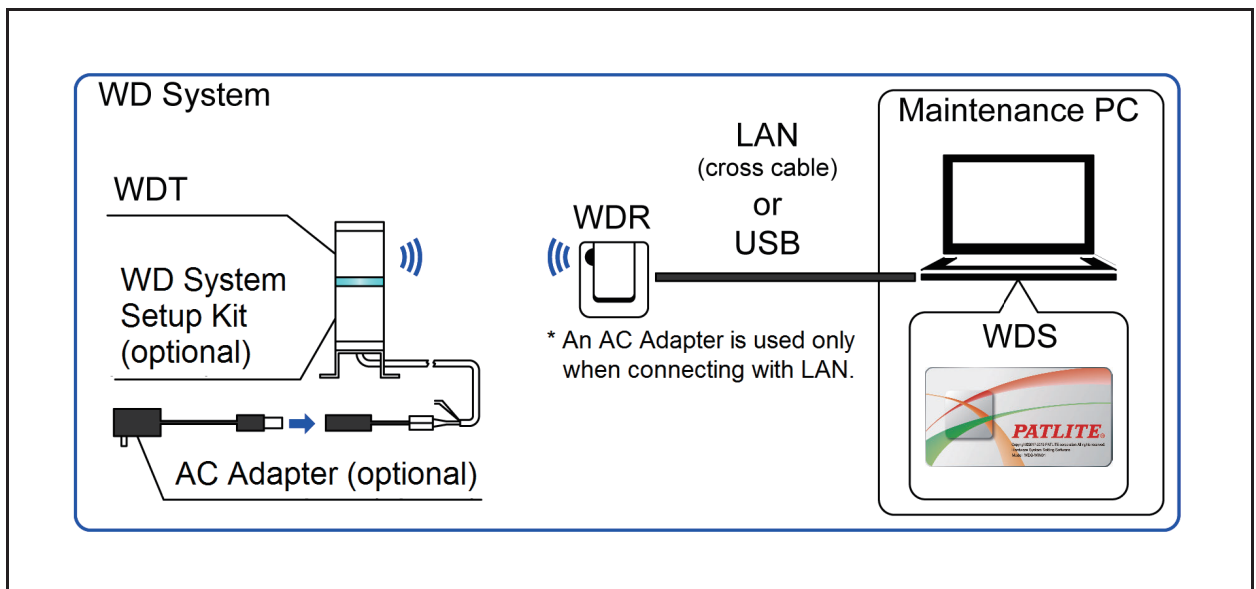

• Configuration

Item	Number of Units Required	Models
WDT	Number as required	WDT-4LR-Z2 WDT-5LR-Z2 WDT-6LR-Z2
WD System Setup Kit (optional)	1 unit	WDX-4LRB WDX-5LRB WDX-6LRB
AC Adapter (optional) *1	1 unit	ADP-001
WDR	1 unit	WDR-L-Z2/WDR-LE-Z2/ WDR-L-Z2-PRO/WDR-L-Z2-PRO-L/ WDR-LE-Z2-PRO/WDR-LE-Z2-PRO-L
WDS	1	WDS-WIN01 (this product)
Maintenance PC	1 unit	–
LAN cable (cross cable) *2 *3	1	–
USB Cable *4 *5	1	–



*1. You can also use the AC Adapter (Z69433003-F1) included with the startup kit (WD-STARTZ2+T0158).

*2. When configuring the WDR LAN settings, connect with a LAN cable.

*3. When connecting the WDR directly to the host PC with a LAN cable, use a cross cable.

*4. Use a USB cable 3 m or shorter.



*5. Do not connect the LAN and USB cables at the same time.

 CAUTION	
 Prohibited	◆ Do not connect the LAN and USB cables to the WDR at the same time. Operation is not possible if connected at the same time.

2.4 Operation Environment

- Use this product in an operating environment that meets the below requirements.



Item			
CPU	Intel® Core™ 2 Duo 2.92 GHz or faster		
Memory	4 GB or more		
Display	XGA resolution (1024 x 768) or higher		
Destination storage device	HDD		
System capacity	Space required for installation 500 MB or more * Separate capacity required for CSV file output.		
Browser	Internet Explorer®11		
Microsoft®.NET Framework	4.5 or later		
Supported operating systems	Operating system name	Bit	User rights
	Windows® 7	32/64	Administrator Users
	Windows® 8.1	32/64	
	Windows® 10	32/64	
	Windows® 11	64	
	Windows® Server 2012 R2	64	
	Windows® Server 2016	64	
	Windows® Server 2019	64	
	Windows® Server 2022	64	
Supported languages	Japanese, English, Simplified Chinese, Traditional Chinese, Korean, Thai, Indonesian, Spanish		
Other	When using this product, turn off the computer's screen saver, sleep, and standby functions.		

 CAUTION	
	<ul style="list-style-type: none"> ◆ Operations with the use of touch panels or tablets cannot be guaranteed. ◆ You cannot install the application or output data collection files to network drives and external storage devices such as SD cards and USB memory. ◆ Data collection does not run properly when the computer's screen saver, sleep, or standby functions are on.

2.5 About license authentication



- This product requires license authentication to use all of its functions.

A license card with a 17-digit license code is provided in paid versions of WDS-WIN01. The steps for license authentication are described in [☞](#) section "6.2.1 License authentication".

 CAUTION	
	<ul style="list-style-type: none">◆ Store the license card for future reference.◆ After uninstalling this product, license authentication is required when re-installing.

3 Functions: Overview

3.1 Function Table

Function	Icon	Description	Compatibility	
			Paid version	Free version
WDT/WDR settings		Set up the WDT and WDR.	X	X
Data collection		Collect signal tower information and save it as CSV data. * License authentication required on paid version.	X	–

3.2 Operation screen layout: Overview

(1) Main menu: screen layout

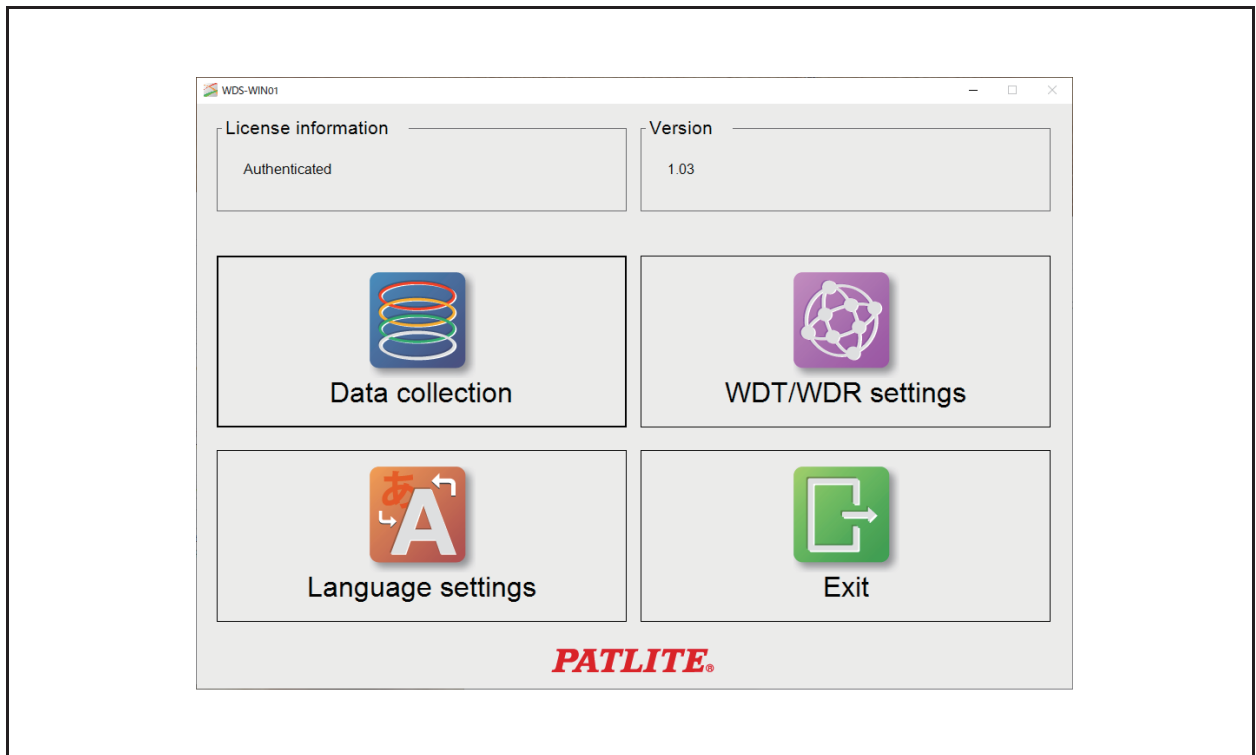

(2) WDT/WDR settings: screen layout

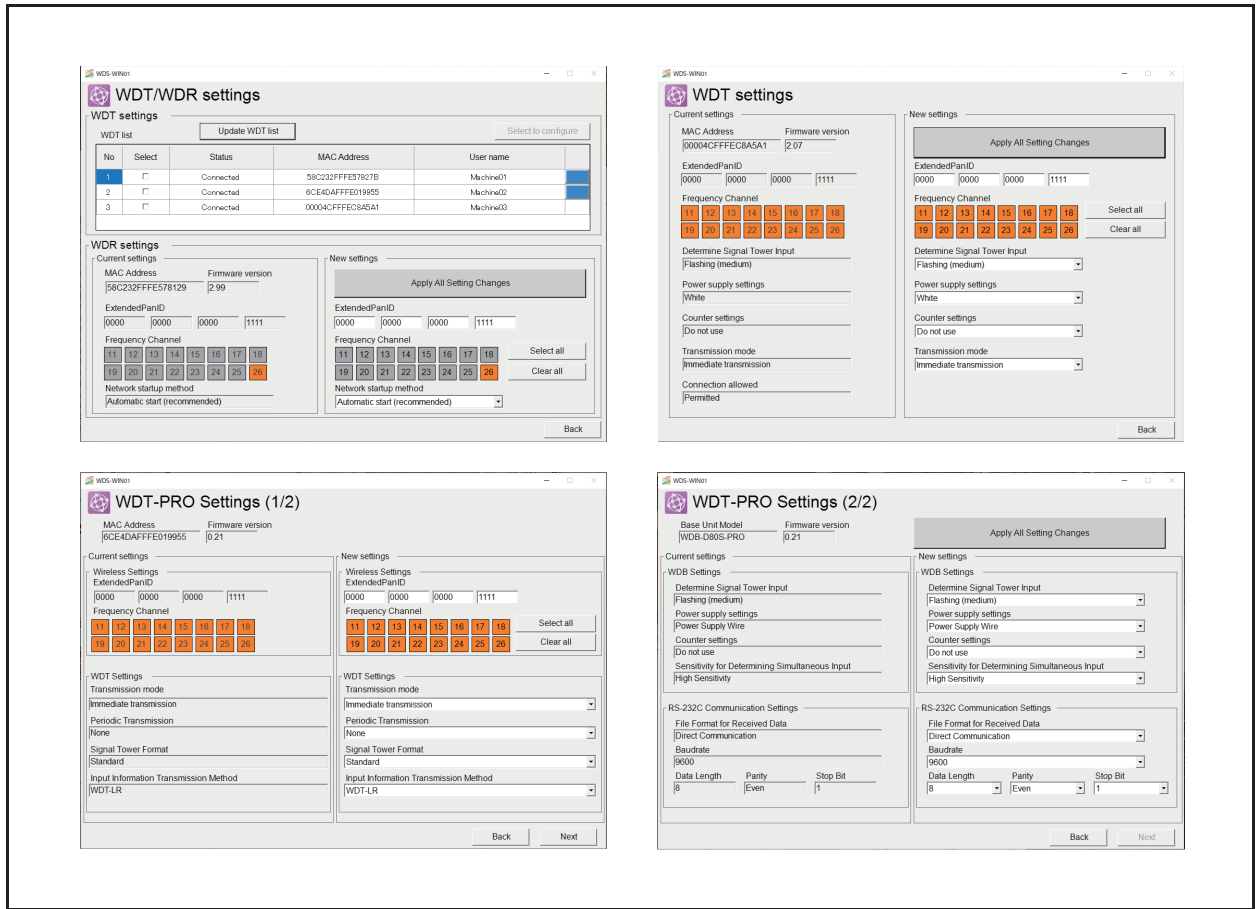

(3) Data collection operation: screen layout

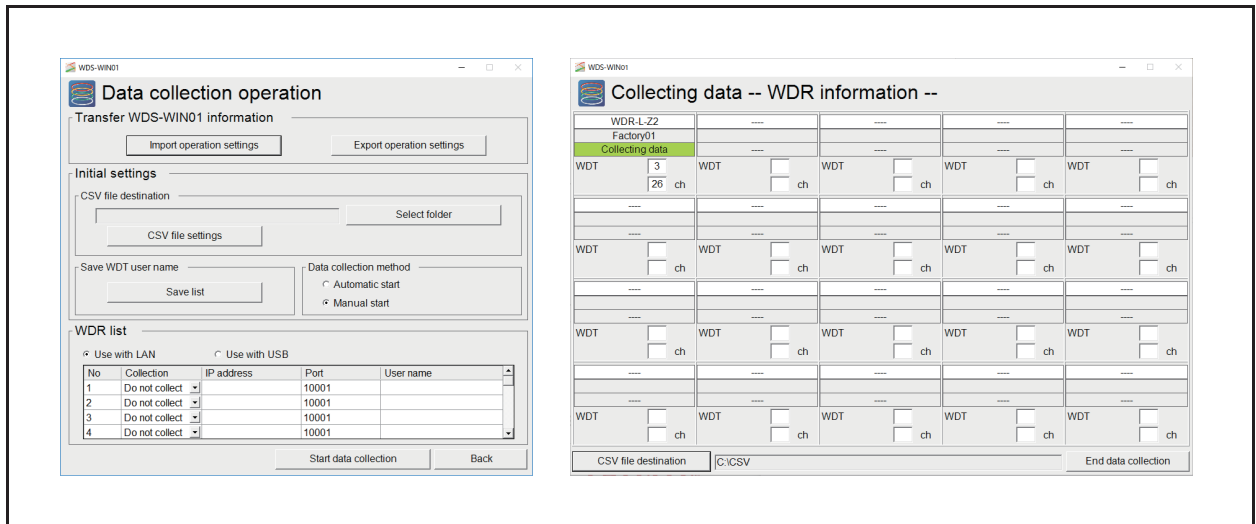

4 Operation guidelines

4.1 Using WDS-WIN01 for the first time

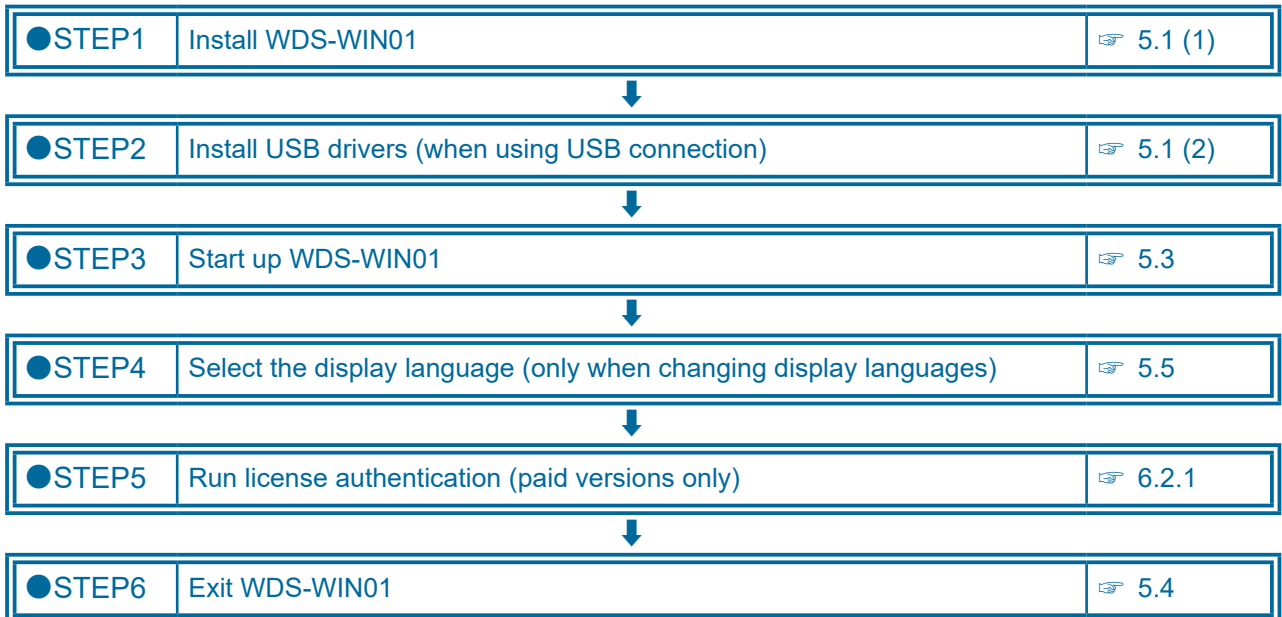

4.2 Setting up the WDT and WDR

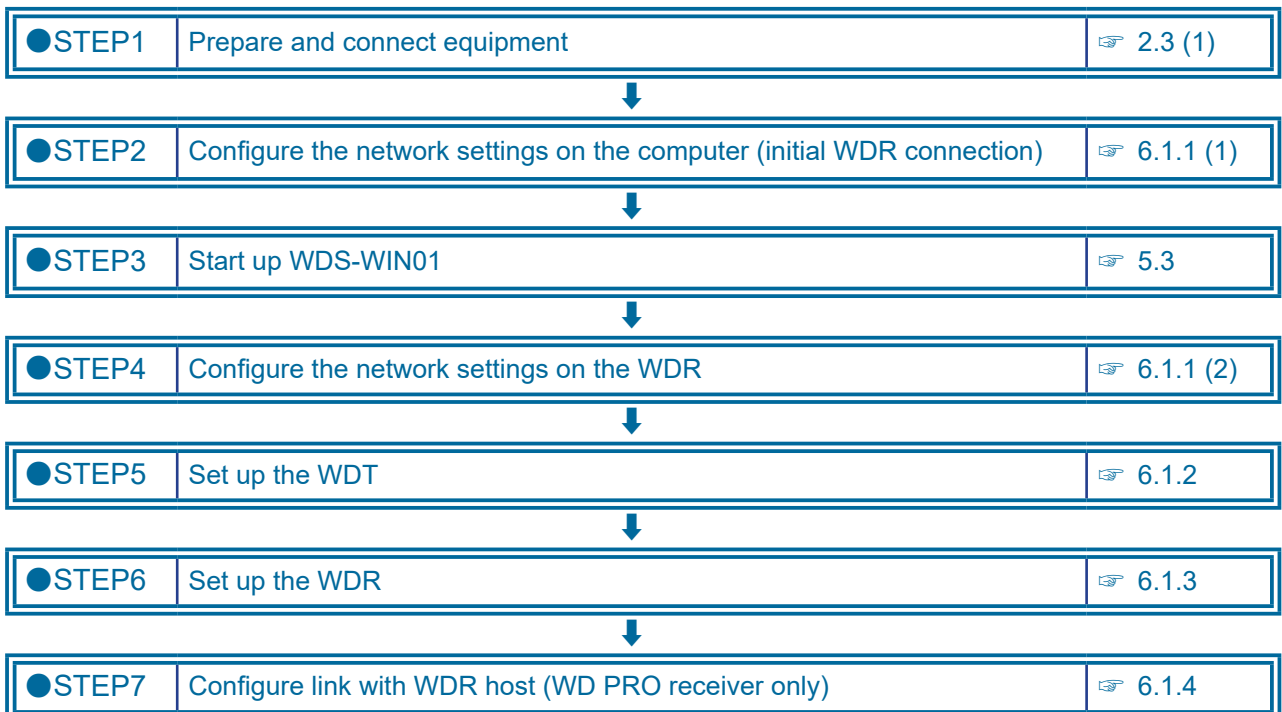

4.3 Checking the WDT and WDR communication status

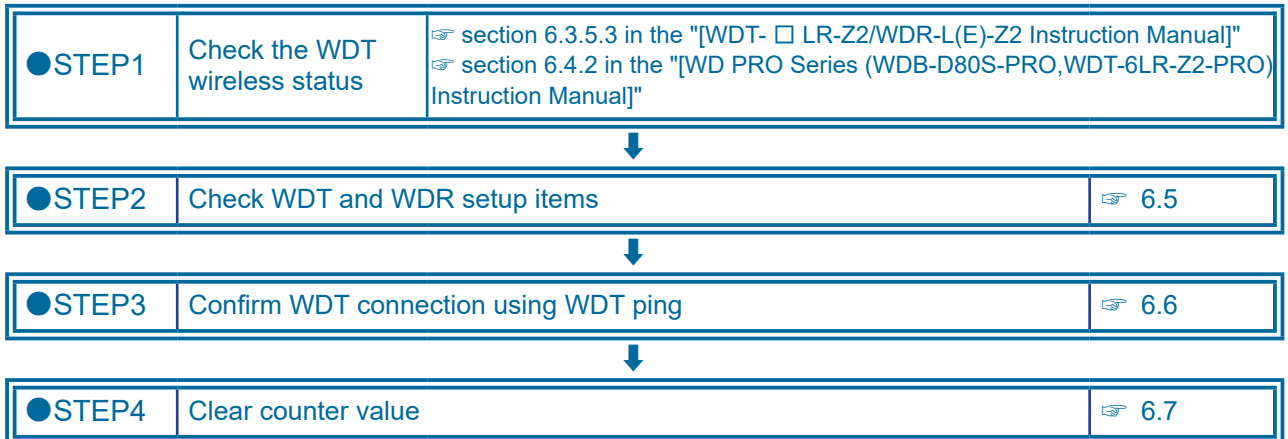

4.4 Running data collection

(1) When configuring settings before collecting data

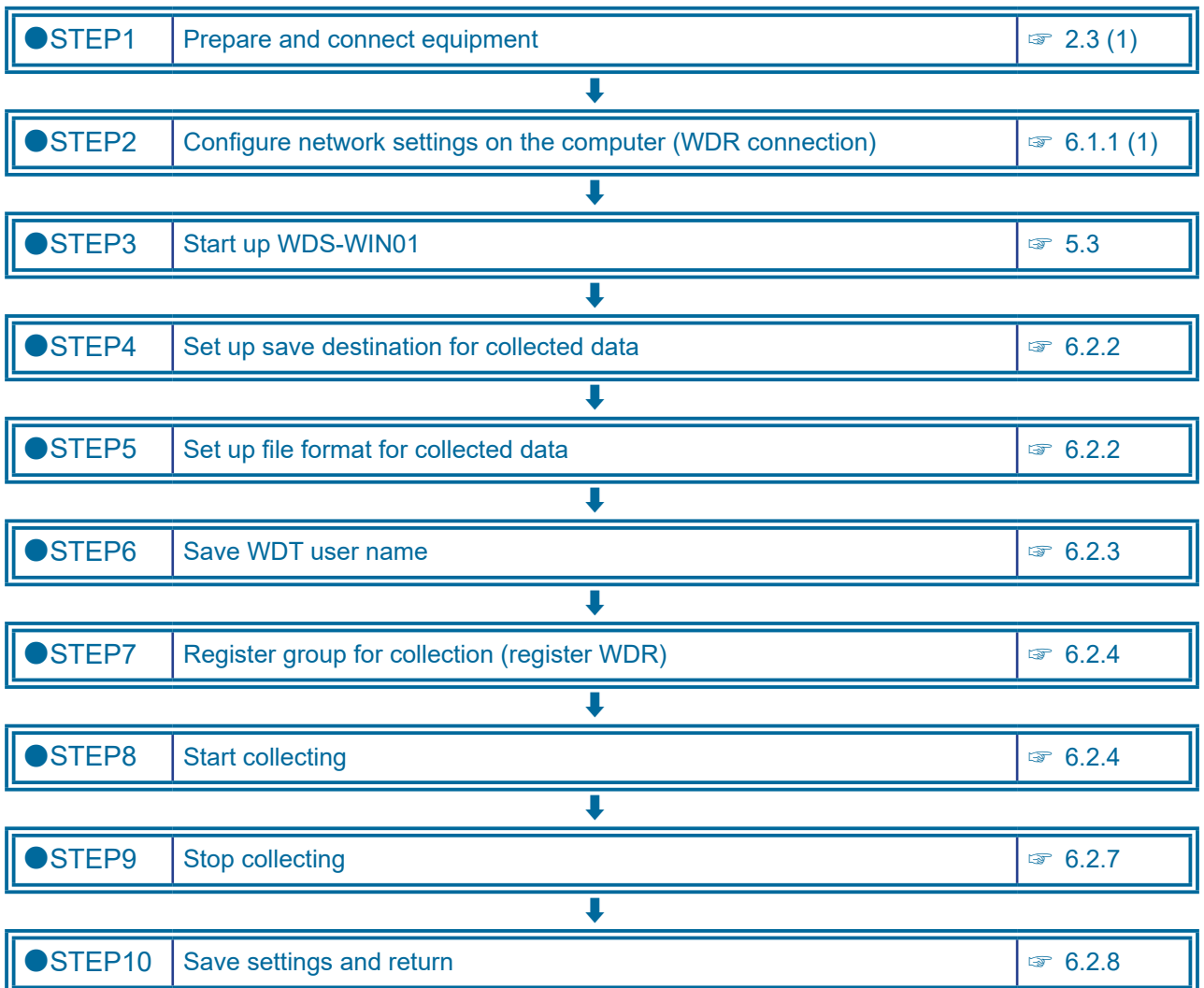

(2) When setup of various settings is already complete

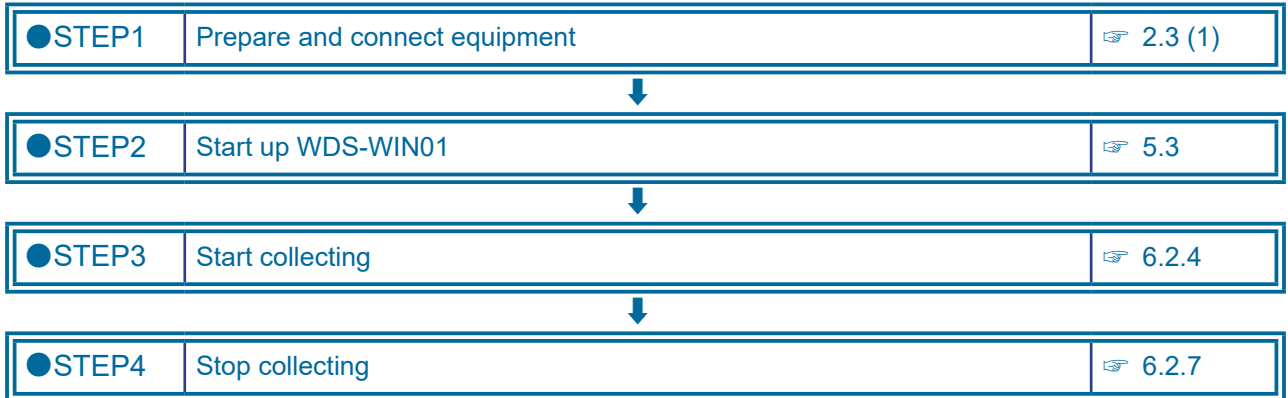

4.5 Export or import data collection settings information

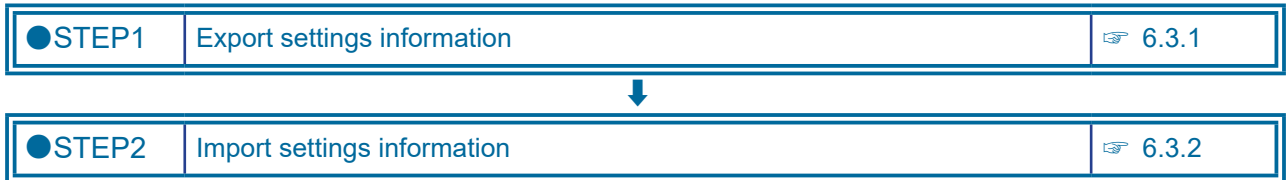

4.6 Import WDS-AUTO2 user name information



4.7 Uninstall WDS-WIN01



5 Installation

This manual uses Windows®10 in the example procedures.

5.1 Installing

⚠ CAUTION	
⚠	◆ When installing this product, the user must be logged in with administrator user rights.

(1) Installing WDS-WIN01

The following steps describe how to install this product.

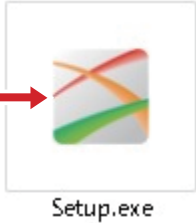
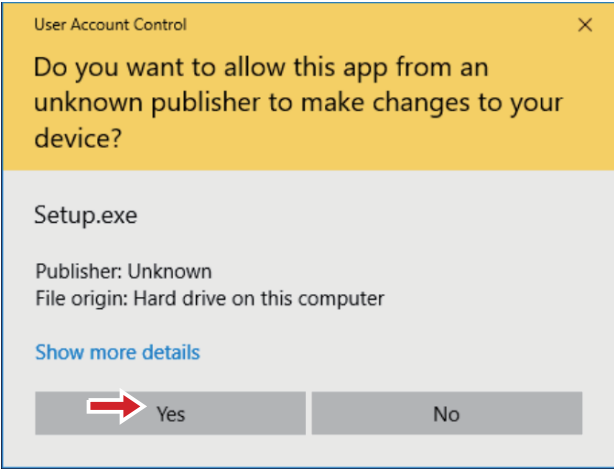
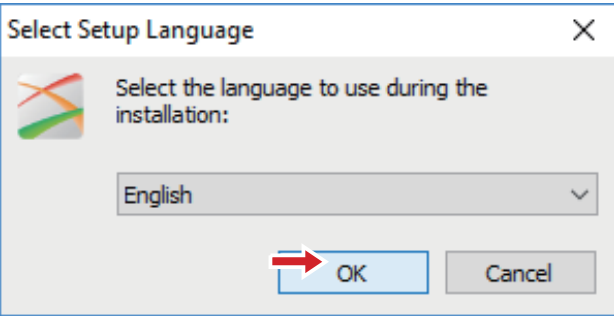
<p>1. ■ Double-click setup.exe.</p>	 <p>Setup.exe</p>
<p>2. ■ If the User Account Control window displays, click [Yes].</p>	
<p>3. ■ Select language and click [OK].</p>	

- 4.
- To continue installation, click [Yes].
 - To export, click [No].

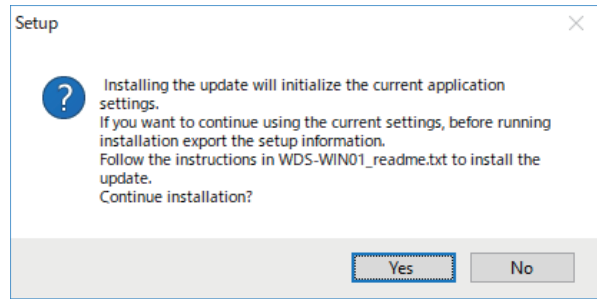

- 5.
- Click [Next].

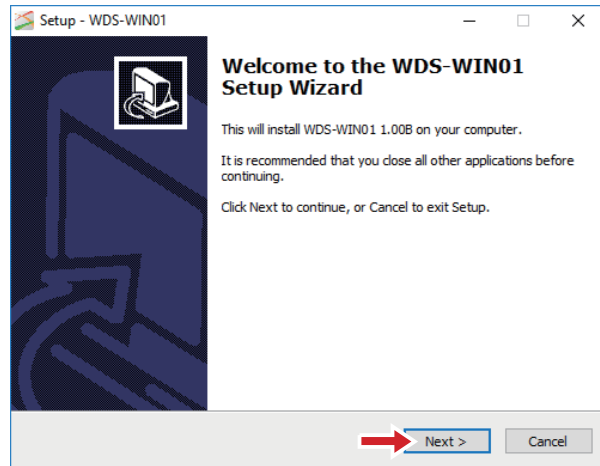

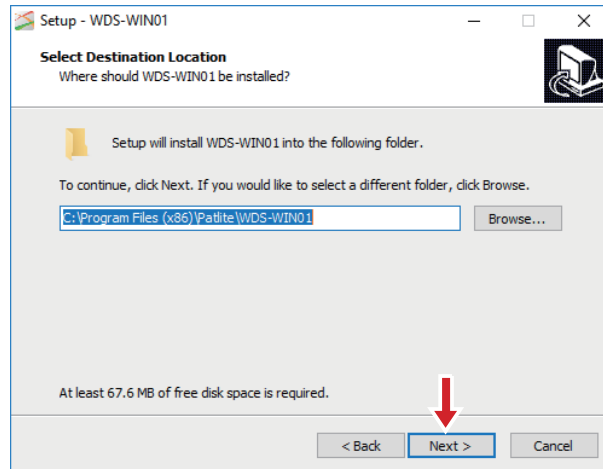

- 6.
- Select destination folder and click [Next].

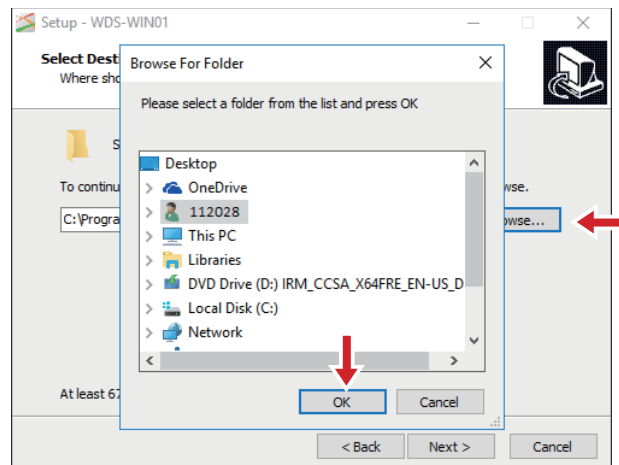

- To change the destination folder, click [Browse].
- Select a folder and click [OK].

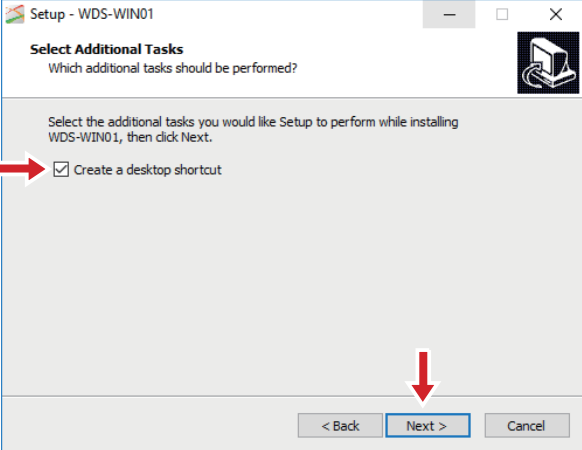
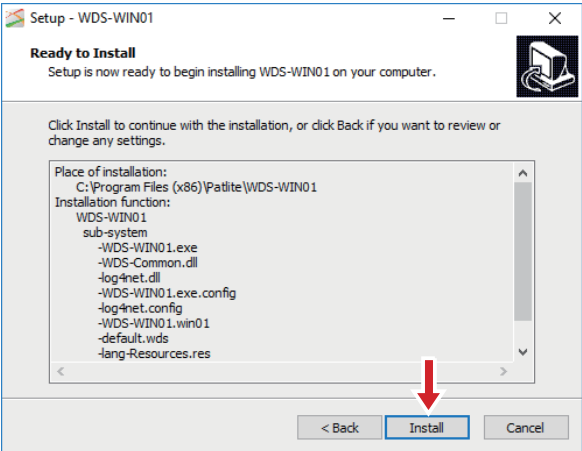
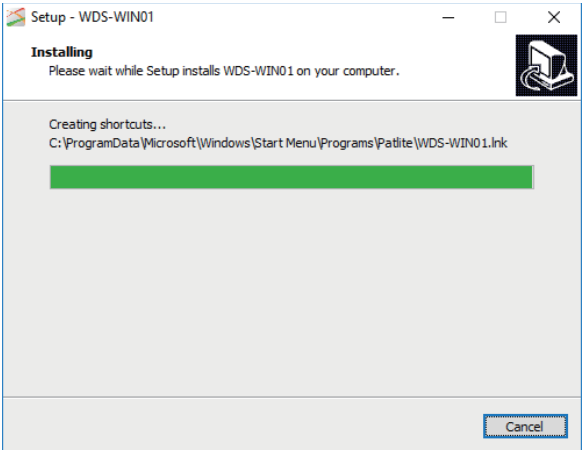

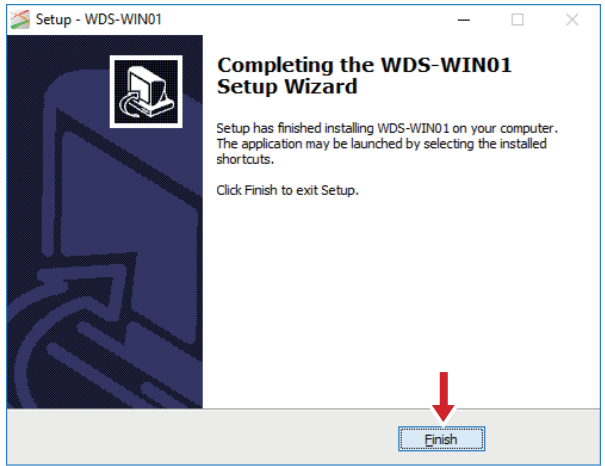
<p>7. ■ Select whether to create a shortcut on the desktop, and click [Next].</p>	
<p>8. ■ Click [Install].</p>	
<p>9. ■ Wait until installation is [Complete].</p>	

<p>10. ■ Click [Finish].</p>	
<p>11. ■ When you select to create an icon on the desktop, a shortcut is created on the desktop.</p>	
<p>12. ■ Finish</p>	<p>—</p>

(2) Install USB drivers (when using USB connection)

 CAUTION	
<p>◆ Depending on the operating system you are using (other than Windows 10), a USB driver may be required. USB drivers are stored in the installation folder [\\patlite\WDS-WIN01\USB_Driver] (refer to section 5.1 (1) 6) path.</p>	

The following describes the installation process on Windows® 7.

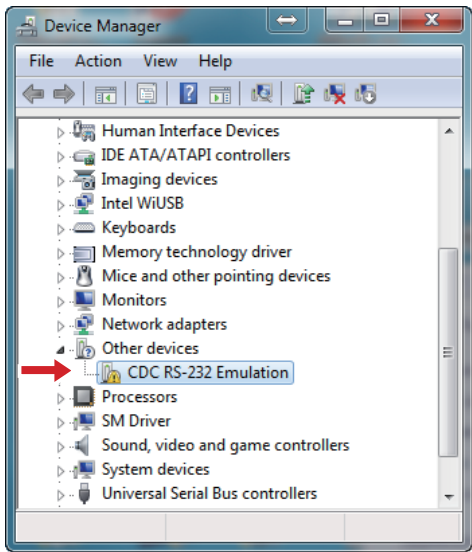
<p>1. ■ Connect the WDR to the computer with a USB cable.</p>	
<p>2. ■ Open the Windows [Device Manager] screen and from [Other devices] double-click [CDC RS-232 Emulation].</p>	

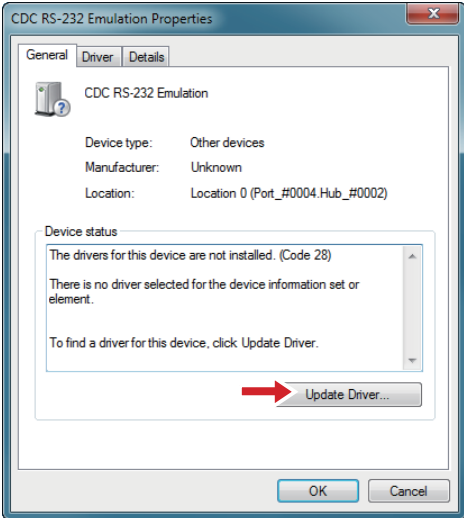
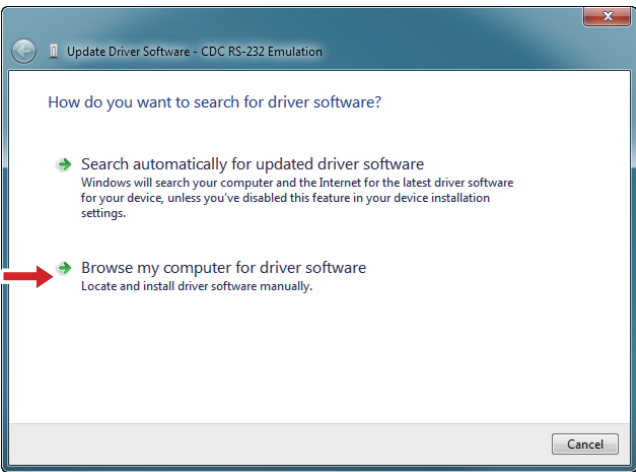
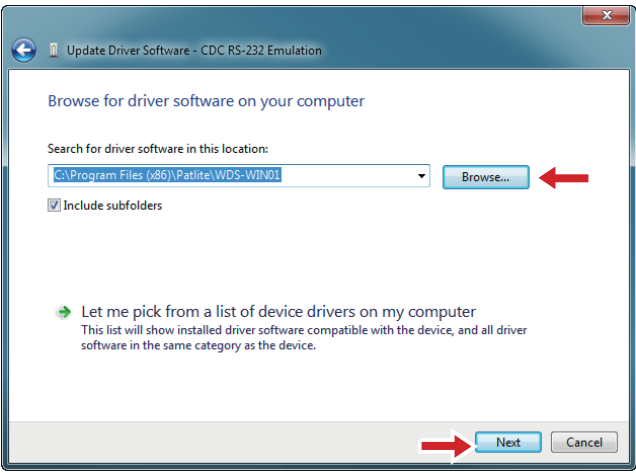
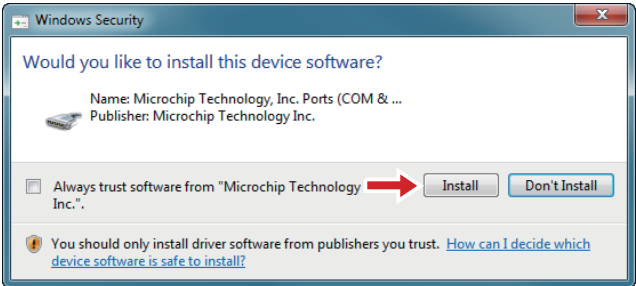

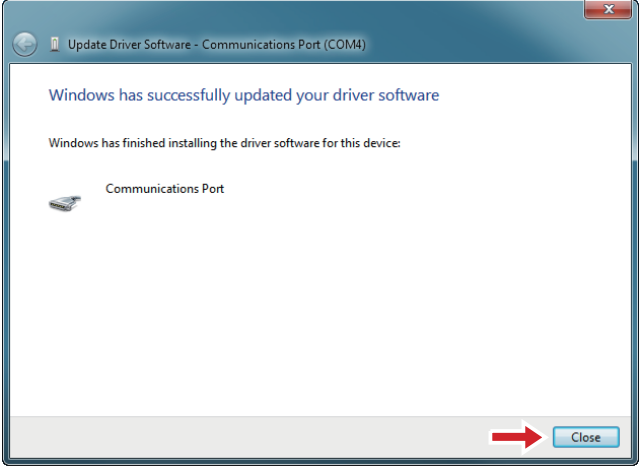
<p>3. ■ Click [Update Driver].</p>	
<p>4. ■ Click the [Browse my computer for driver software] option.</p>	
<p>5. ■ Select the USB driver destination (folder defined in section [5.1 (1) 6]) and click [Next].</p>	
<p>6. ■ Click [Install].</p>	

<p>7.</p> <ul style="list-style-type: none">■ Installation starts up.■ Click [Close].	
<p>8.</p> <ul style="list-style-type: none">■ Finish	<p>—</p>

5.2 Uninstalling

⚠ CAUTION	
⚠	◆ When uninstalling this product, the user must be logged in with administrator user rights.

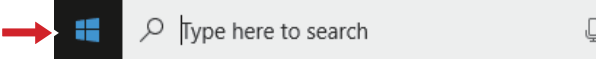

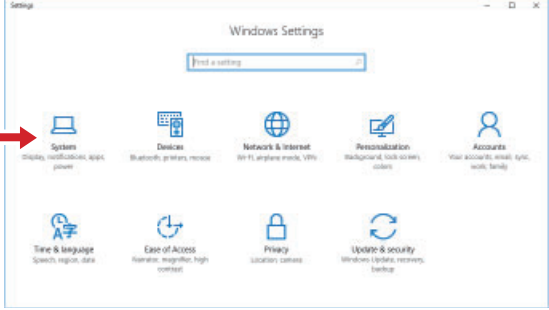
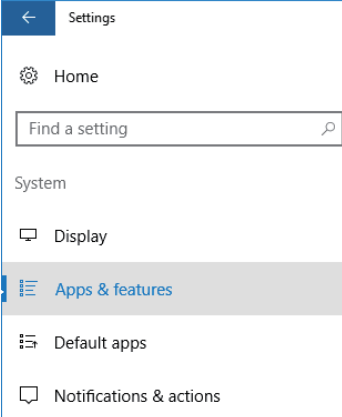
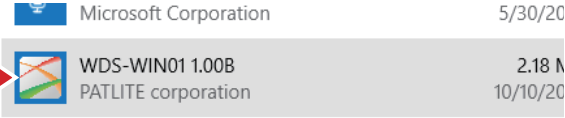
The following steps describe how to uninstall this product.

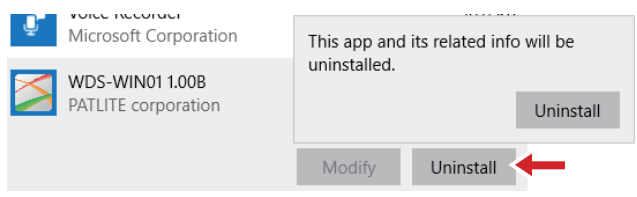
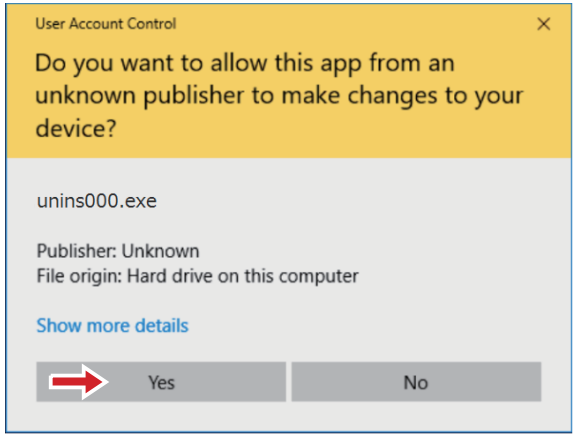
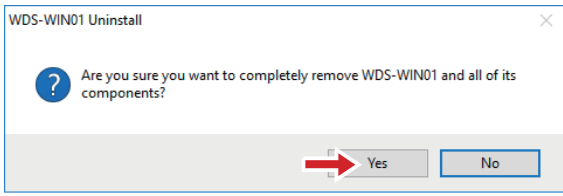
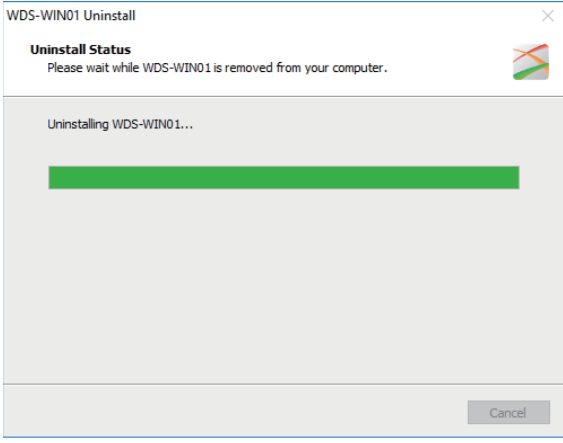
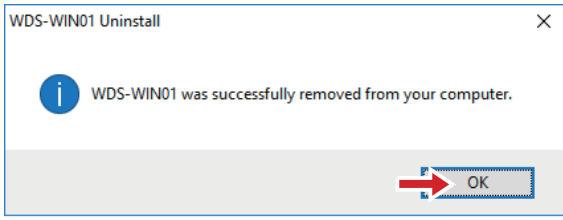
1.	■ From the taskbar, click [Start].	
2.	■ From the [Start] menu, click [Settings].	
3.	■ From the [Settings] menu, click [System].	
4.	■ From the [System] menu, click [Apps & Features].	
5.	■ Locate [WDS-WIN01] and click it.	

<p>6. ■ Click [Uninstall].</p>	
<p>7. ■ If the User Account Control window displays, click [Yes].</p>	
<p>8. ■ Click [Yes].</p>	
<p>9. ■ Wait until the uninstall process is complete.</p>	
<p>10. ■ Click [OK].</p>	
<p>11. ■ Finish (You do not need to restart your computer.)</p>	<p>—</p>

5.3 Starting WDS-WIN01

(1) When you created a shortcut icon on the desktop

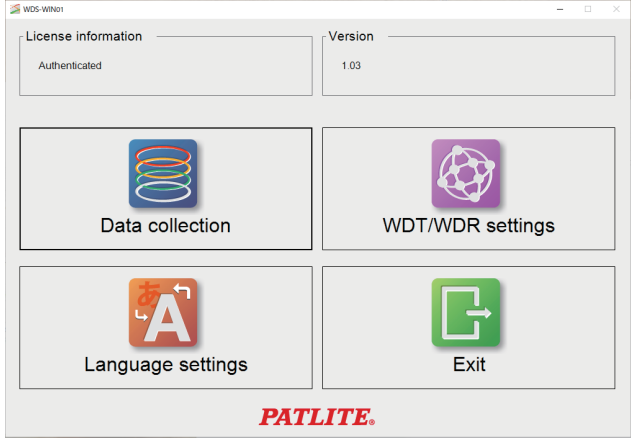
<p>1. ■ Double-click the shortcut icon.</p>	
<p>2. ■ The screen as shown on the right appears for a few moments.</p>	
<p>3. ■ The Main menu appears.</p>	
<p>4. ■ Finish</p>	<p style="text-align: center;">-</p>

(2) When there is no shortcut icon on the desktop

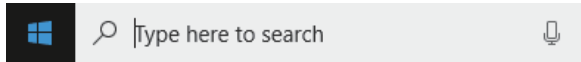
<p>1. ■ Start the application from the Windows Start menu.</p>	
---	--

5.4 Exiting WDS-WIN01

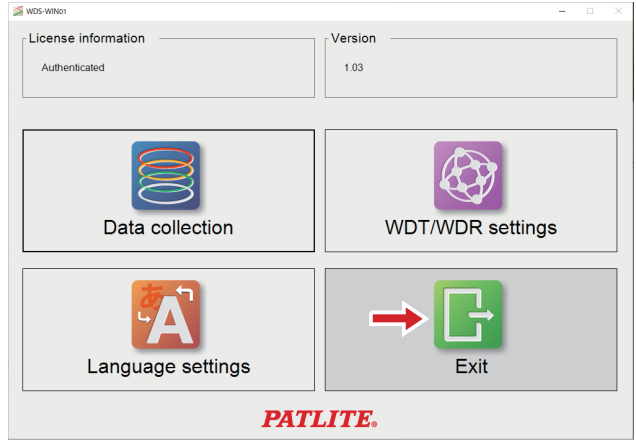
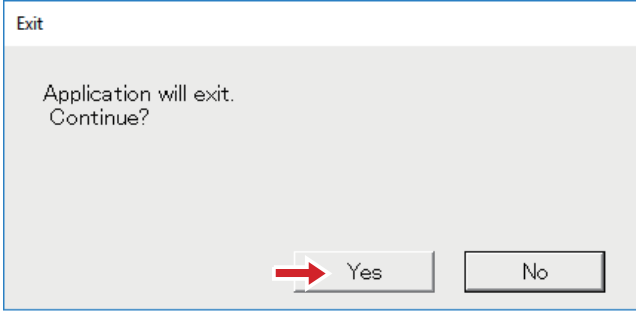
<p>1. ■ From the Main menu, click [Exit].</p>	
<p>2. ■ Click [Yes].</p>	
<p>3. ■ Finish</p>	<p style="text-align: center;">-</p>

5.5 Changing the display language

- 1.** ■ These instructions describe changing the display language from English to Japanese. From the Main menu, click [Language settings].

* Although these steps explain changing the language to Japanese, the same steps apply when changing to other languages.

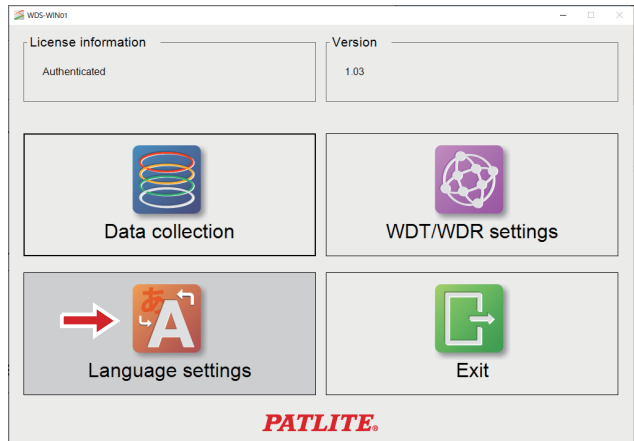

- 2.** ■ From the pull-down list select [Japanese].

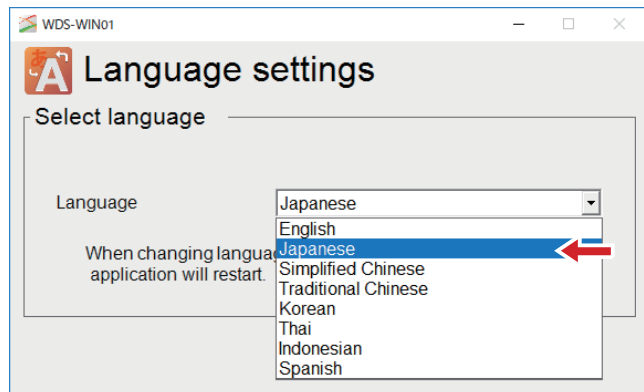

- 3.** ■ Click [Change].

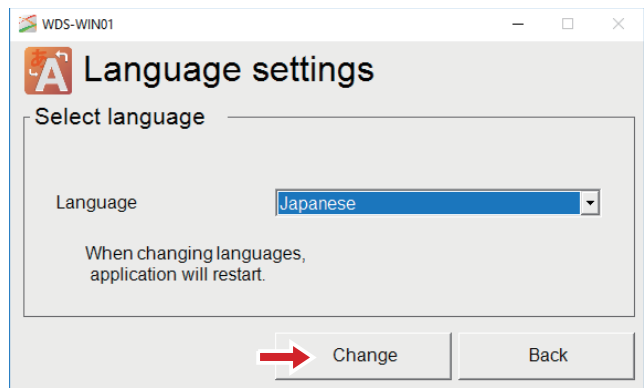

4. ■ The application will restart, and the Main menu will be displayed in Japanese.



5. ■ Finish

 CAUTION



- ◆ The language settings of your operating system affects the application's initial display language.
 - ・ For Japanese operating systems, displays Japanese.
 - ・ Other language operating systems, displays English.
- ◆ After changing the display language, the application will start up in the selected language.

6 Operation

6.1 WDT/WDR settings

6.1.1 WDR network settings

(1) Set up the computer's IP address.

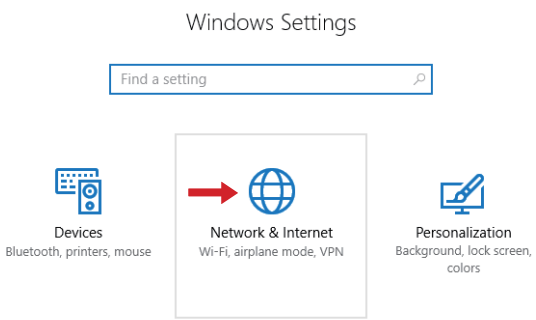
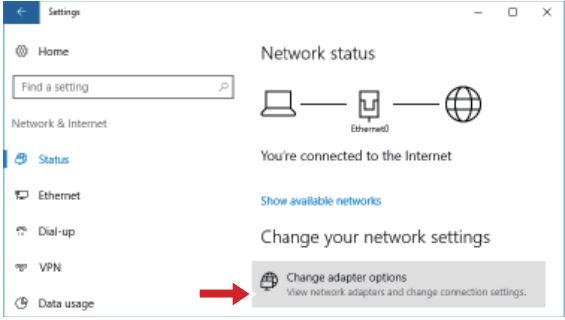
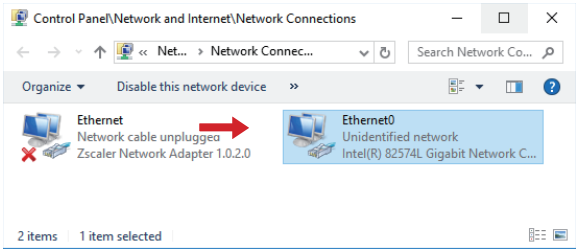
<p>1. ■ From the Windows [Start] menu, click [Settings].</p>	
<p>2. ■ From the [Settings] menu, click [Network & Internet].</p>	
<p>3. ■ From the [View network status and tasks] menu, click [Change adapter options].</p>	
<p>4. ■ Double-click the WDR connection, either [Ethernet] or [Local Area Connection].</p>	

5. ■ Click [Properties].

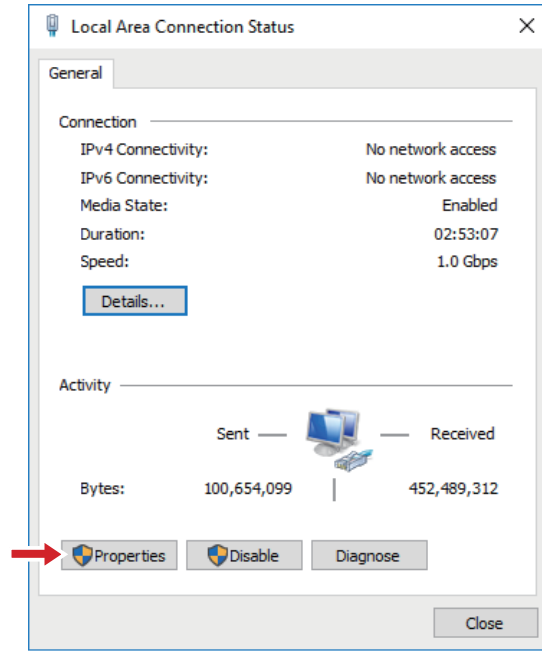

6. ■ Select [Internet Protocol Version 4 (TCP/IPv4)].
 ■ Click [Properties].

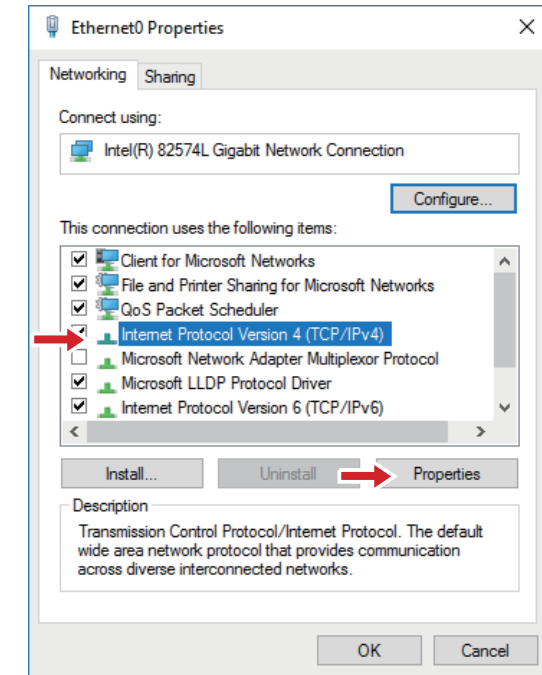

- 7.**
- Enter the following settings.
 - IP address
 - Subnet mask
 - Default gateway
 - * When connecting to WDR for the first time, set the following:
 - IP address
 - WDR-L-Z2/ WDR-LE-Z2
192.168.0.* (replace asterisk * with any value other than 1)
 - WD PRO receiver
192.168.10.* (replace asterisk * with any value other than 1)
 - Subnet mask
255.255.255.0
 - Default gateway
0.0.0.0
 - * Determine beforehand the settings you plan to use at run time.
 - Click [OK].

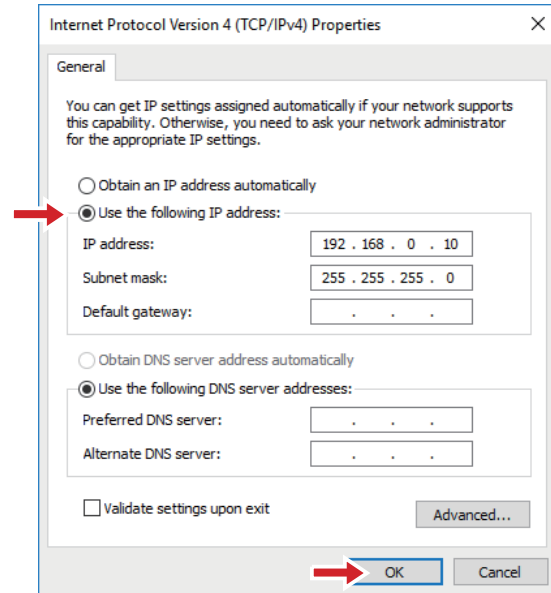

- 8.**
- Finish

(2) Set up the WDR's IP address.

- When receiver is WDR-L-Z2/WDR-LE-Z2
(WD PRO receiver, refer to "When receiver is WD PRO")

1. ■ Connect the WDR to the computer with a LAN cable.

For details on connecting, refer to section "2.3 (1) ② Maintenance System Configuration".

2. ■ From the Main menu, click [WDT/WDR settings].

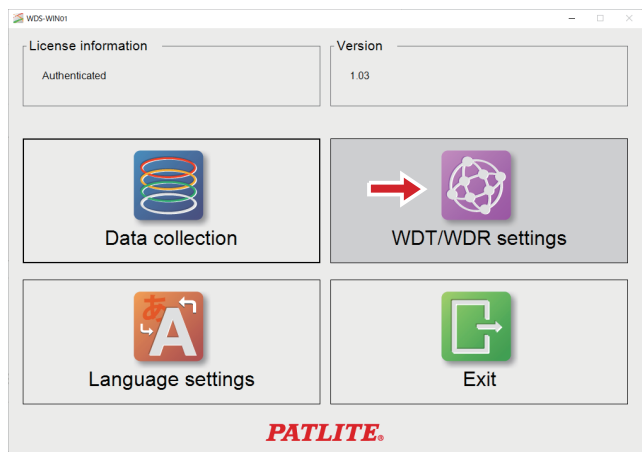

3. ■ Under [Use with LAN], click [WDR IP address settings].

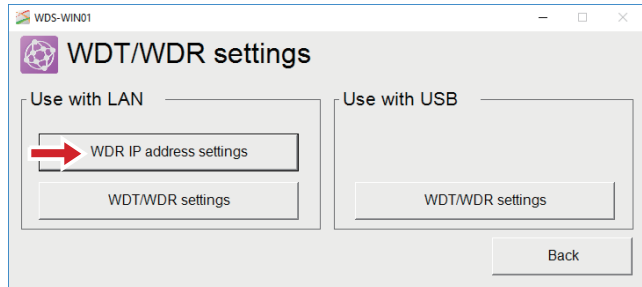

4. ■ Enter the current IP address of the connected WDR.

When setting up the WDR for the first time, enter 192.168.0.1 for the initial IP address.

■ After entering the address, click [Start browser].

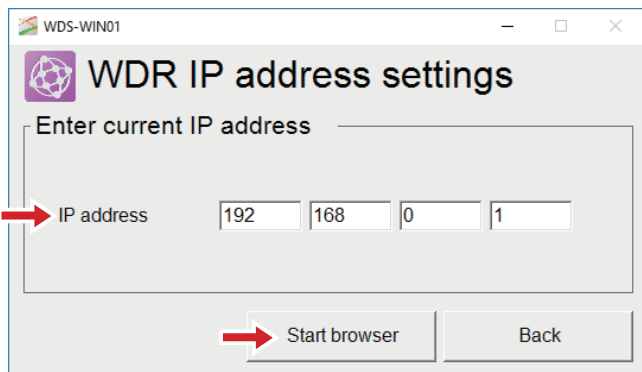

- 5.** ■ The browser starts up and the access control window will appear.

(Because a user name and password have not yet been set up, leave fields blank.)

- Click [OK].



- 6.** ■ The [XPort®] browser appears.

- As shown in the image to the right, click [Network].

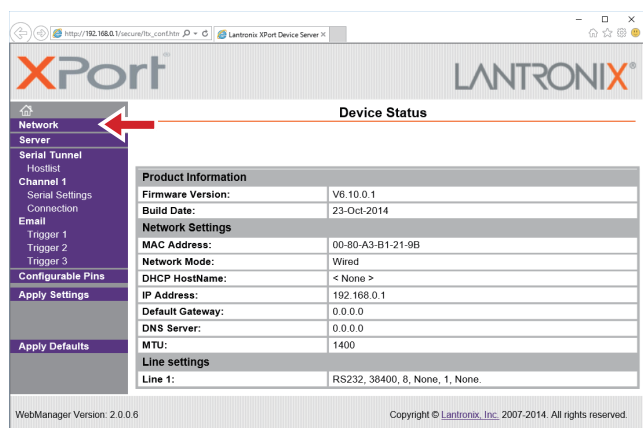

- 7.**
- The [Network Settings] screen appears.
 - * Depending on the version of your Internet Explorer®, the screen may not display properly. Make sure Internet Explorer® compatibility view is enabled.
 - Make sure [Use the following IP configuration] is selected, and enter the following fields:
 - [IP Address]
 - [Subnet Mask]

Enter the following fields as required.

 - [Default Gateway]
 - [DNS Server]

If no entry is required, enter 0.0.0.0 in the corresponding fields.
 - * For information on settings, refer to section "7.1.2 WDR settings (computer connection settings)".
 - Click [OK].

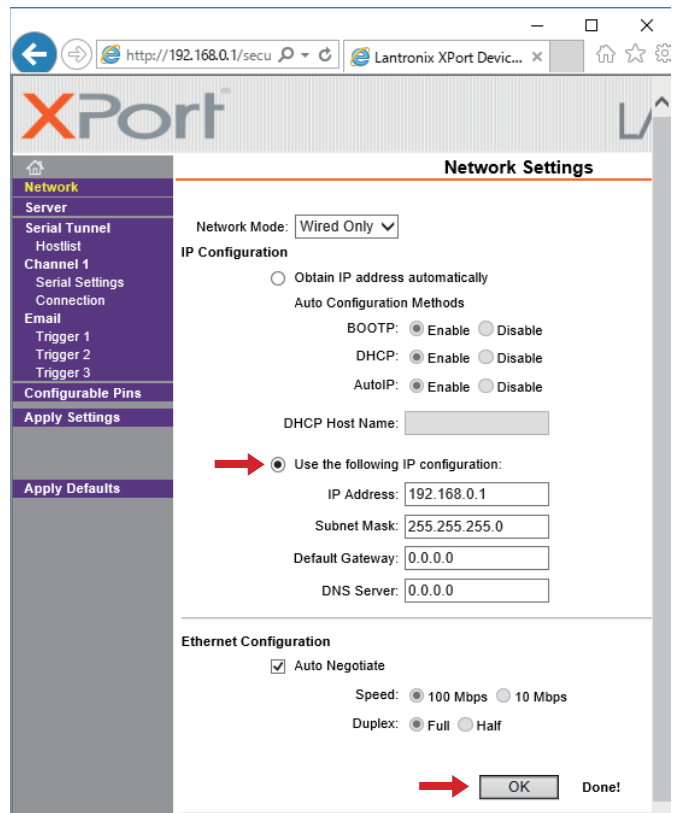

- 8.**
- You can change the port number by following the steps below.
 - * Normally, change is unnecessary. Skip to step 10 if you are not changing the port number.
 - Click [Connection].



- 9.**
- The [Connection] screen appears.
 - Enter the port number in the [Local Port] field.
 - Click [OK].

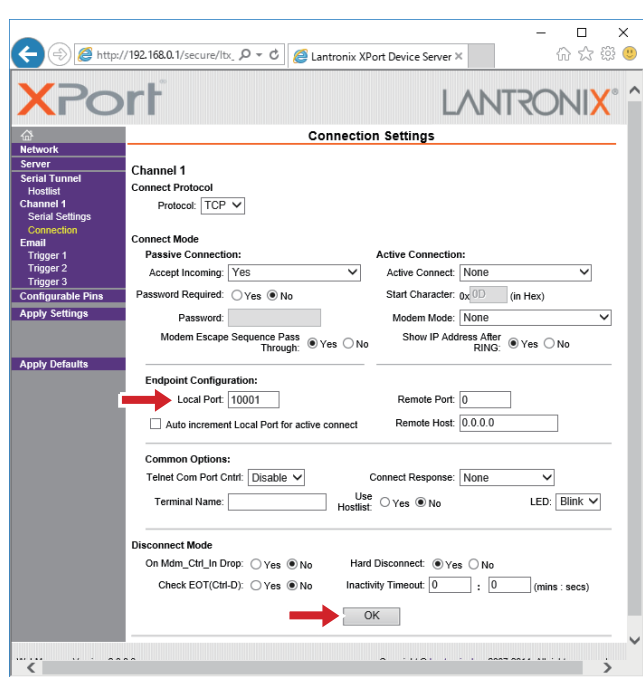

- 10.**
- Confirm the changes.
From the menu, click [Apply Settings].
 - * Do not click [Apply Defaults] at the bottom of the menu. This will cause the WDR to not function properly.
- If you accidentally click [Apply Defaults], follow the below steps:
- Open the "[WDT- □ LR-Z2/WDR-L(E)-Z2 Instruction Manual]".
 - Follow the steps in section 7.2 (5) "[Initializing WDR LAN communication settings]".
 - Reset the network settings.

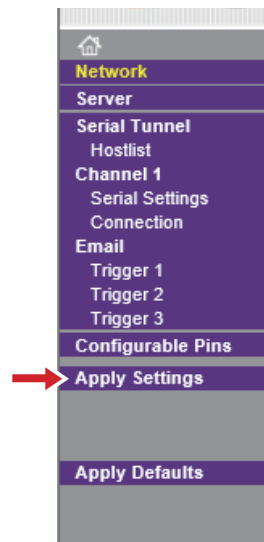

- 11.**
- Click [OK].

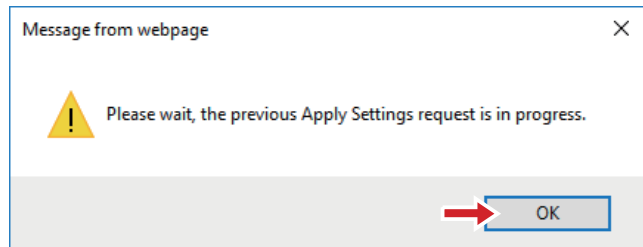

- 12.**
- Click [X] to close the browser.

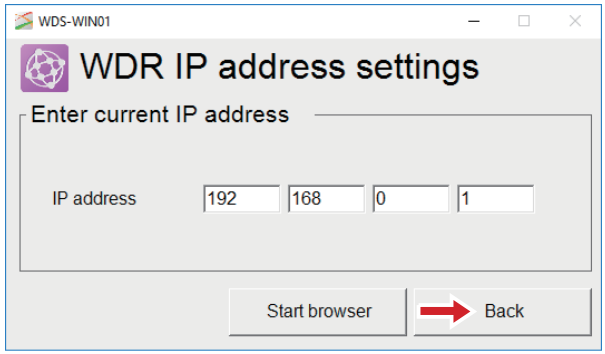

<p>13. ■ Click [Back].</p>	
<p>14. ■ Finish</p>	<p>—</p>

■ When receiver is WD PRO

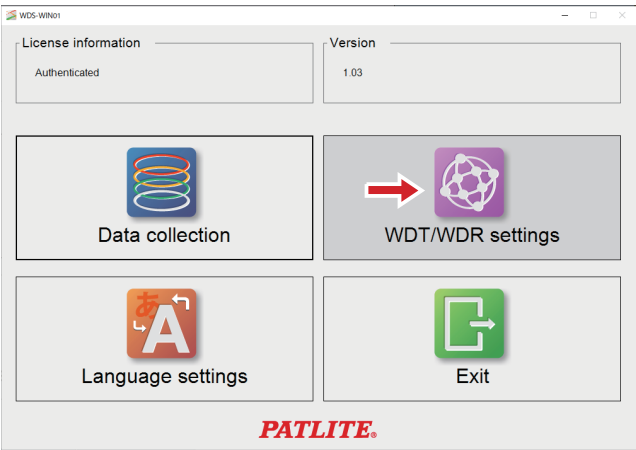
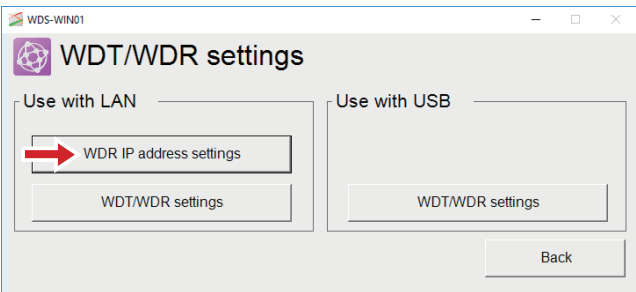
<p>1. ■ Connect the WDR to the computer with a LAN cable.</p> <p>■ For details on connecting, refer to  section "2.3 (1) ② Maintenance System Configuration".</p>	<p>—</p>
<p>2. ■ From the Main menu, click [WDT/WDR settings].</p>	
<p>3. ■ Under [Use with LAN], click [WDR IP address settings].</p>	

4.

- Enter the current IP address of the connected WDR.

When setting up the WDR for the first time, enter 192.168.10.1 for the initial IP address.

- After entering the address, click [Start browser].

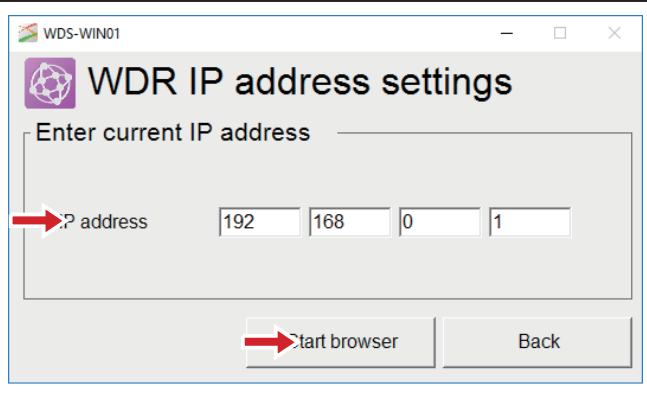

5.

- The browser starts and the login screen appears.
- Enter the user name and password.

When you log in to the WDR WEB screen for the first time, the user name and password setting screen will be displayed depending on the firmware version, so be sure to set the user name and password.

※ If the firmware version is 1.02 or earlier, the initial user name and password are "patlite" and "patlite".

- Click [Login].



6.

- The Top screen appears.
- Click the [System Settings] tab, then click [Network Settings].

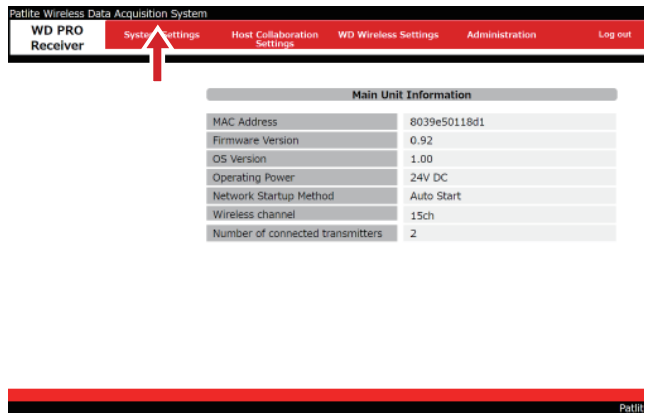

- 7.**
- The [Network Settings] screen appears.
 - Select the IP Address Configuration method, and enter the following fields:
 - [IP Address]
 - [Subnet Mask]

Enter the following fields as required.

 - [Default Gateway]
 - [DNS Server]
 - [Host Name]

If no entry is required, enter 0.0.0.0 in the corresponding fields.
 - * Refer to  section 7.3.2.1 Network Settings, in the "[WDT- □ LR-Z2/WDR-L(E)-Z2-PRO(-L) Instruction Manual]".
 - Click [OK].

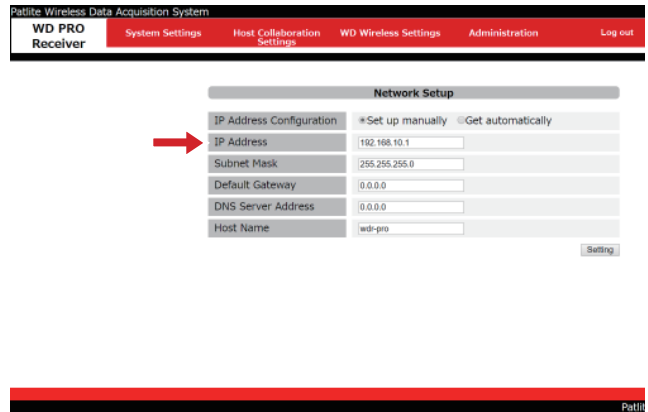

- 8.**
- Click [Settings].

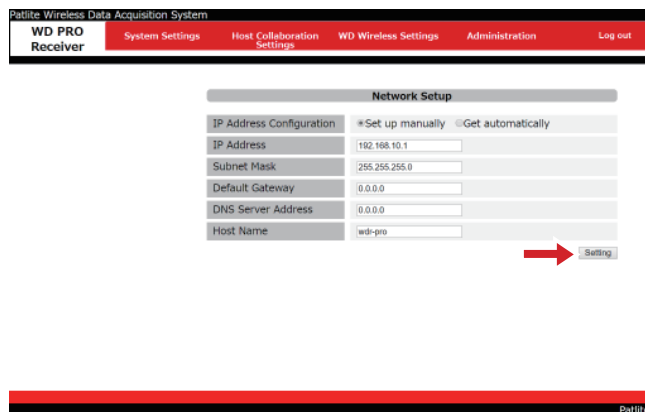

- 9.**
- When setup is complete, the complete screen is displayed.

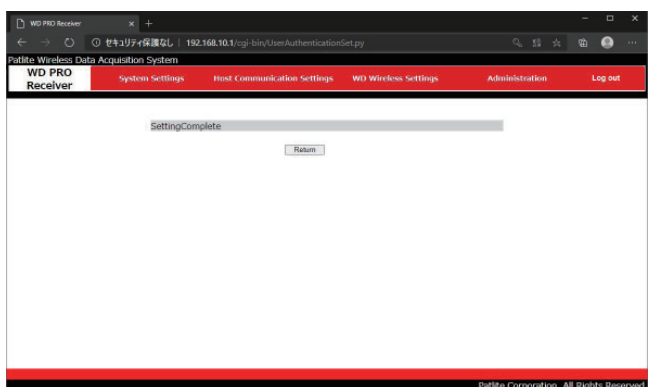

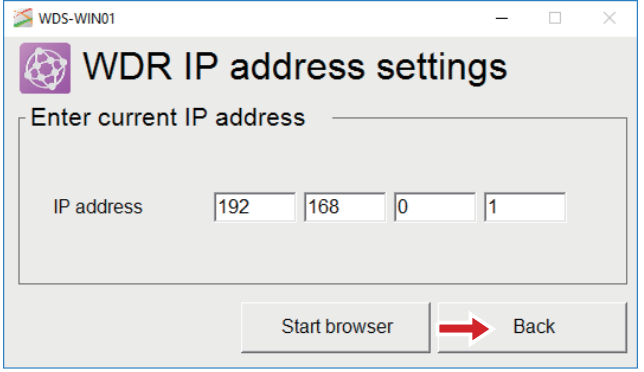
<p>10. ■ Click [X] to close the browser.</p>	
<p>11. ■ Click [Back].</p>	
<p>12. ■ Finish</p>	<p style="text-align: center;">-</p>

6.1.2 WDT setup

NOTICE
<p>◆ For information on wireless channels, groups, ExtendedPanID, and MAC addresses, refer to section 6.1 "Before Installation" in the "[WDT- □ LR-Z2/WDR-L(E)-Z2-PRO(-L) Instruction Manual]".</p>

CAUTION	
 Mandatory	<ul style="list-style-type: none"> ◆ By default, the ExtendedPanID of the WDT is 0000 0000 0000 0000, which is the value for universal search mode, and will usually link to the closest receiver grouping. To avoid interference of groupings, change the ExtendedPanID of the WDT during configuration. ◆ When collecting data with this product, set WDT [Transmission mode] field to [Immediate transmission].

(1) When using LAN

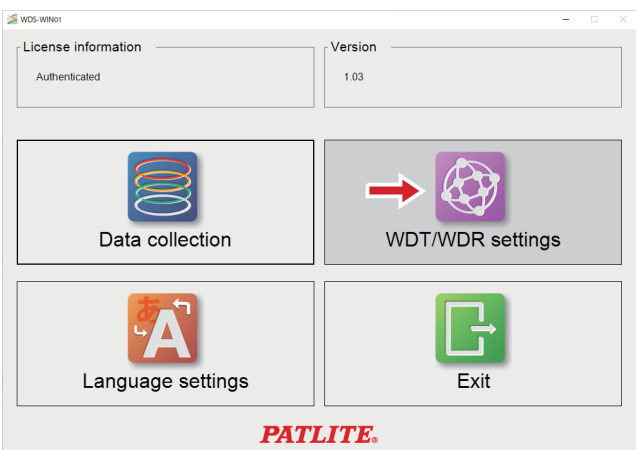
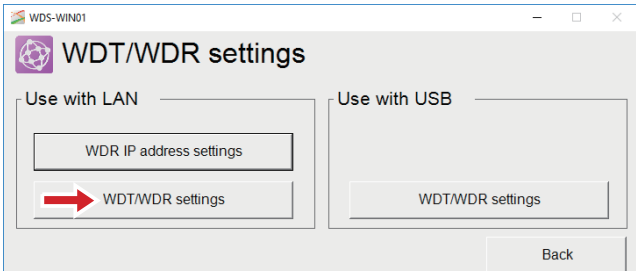
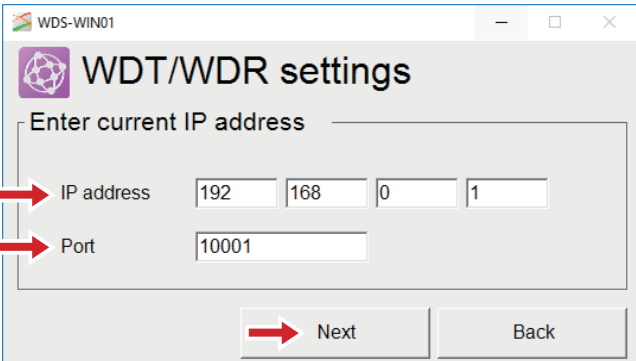
<p>1.</p> <ul style="list-style-type: none"> * Connect and power on the WDR and WDT as per the system configuration. Refer to  section "2.3 (1) System Configuration". ■ From the Main menu, click [WDT/WDR settings]. 	 <p>The screenshot shows the main menu of the WDS-WIN01 software. It features a license information box at the top left, a version box at the top right, and four main menu items: 'Data collection', 'WDT/WDR settings' (highlighted with a red arrow), 'Language settings', and 'Exit'. The 'PATLITE' logo is at the bottom.</p>
<p>2.</p> <ul style="list-style-type: none"> ■ Under [Use with LAN], click [WDT/WDR settings]. 	 <p>The screenshot shows the 'WDT/WDR settings' dialog box. It has two sections: 'Use with LAN' and 'Use with USB'. Under 'Use with LAN', there are three buttons: 'WDR IP address settings', 'WDT/WDR settings' (highlighted with a red arrow), and another 'WDT/WDR settings' button. A 'Back' button is at the bottom right.</p>
<p>3.</p> <ul style="list-style-type: none"> ■ Enter the current IP address of the connected WDR. · If you have not changed the WDR IP address from its default setting, enter 192.168.0.1. * On the WD PRO receiver, the initial value is 192.168.10.1. · If you did not change the port number in procedure "6.1.1 (2)", do not change its default value of 10001. · If you changed the port number in procedure "6.1.1 (2)", enter the same port number. ■ Click [Next]. 	 <p>The screenshot shows the 'WDT/WDR settings' dialog box with the 'Enter current IP address' section. The 'IP address' field is split into four boxes containing '192', '168', '0', and '1'. The 'Port' field contains '10001'. Red arrows point to the IP address and Port labels. 'Next' and 'Back' buttons are at the bottom.</p>

- 4.**
- The [WDT list] under [WDT settings] shows the WDT units that are currently connected.
 - * It may take about 10 seconds to display the WDT list.
 - Select the check boxes of WDT to set up, and click [Select to configure].

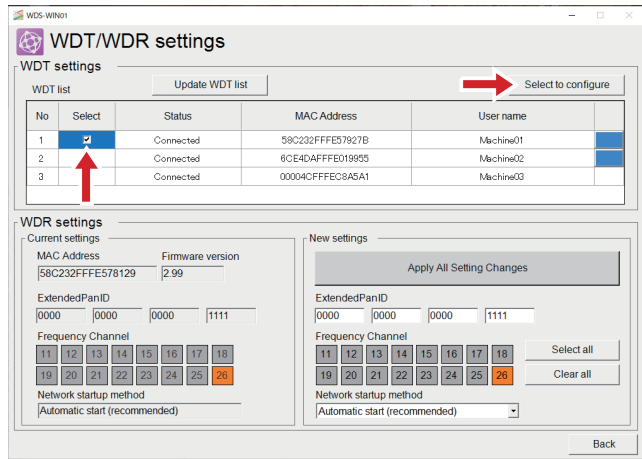

- 5.** [For WDT]
- Set up the following fields:
 - [ExtendedPanID]
 - [Frequency Channel]
 - [Determine Signal Tower Input]
 - [Power supply settings]
 - [Counter Settings]
 - [Transmission mode]

* When collecting data with this product, set [Transmission mode] field to [Immediate transmission].

* Some models and versions do not support [Counter Settings]. For information, refer to section "7.1.1 (3) ⑤ Counter Settings".

* For information about each item, refer to section "7.1.1 WDT settings".

- After setup is complete, click [Apply All Setting Changes].

The settings are applied to the WDT.

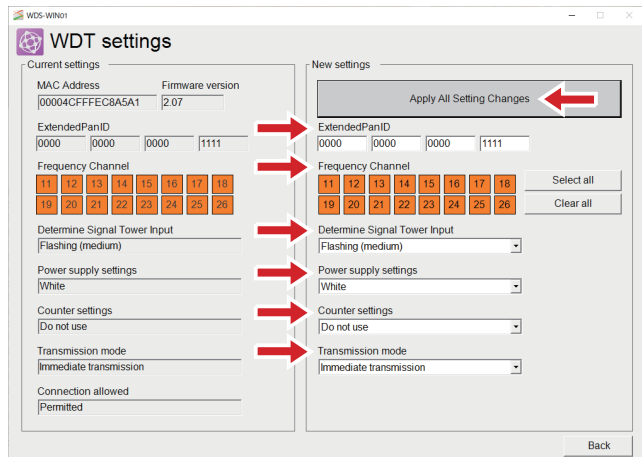

【For WDT-PRO】

- Set up the following fields:
 - [ExtendedPanID]
 - [Frequency Channel]
 - [Determine Signal Tower Input]
 - [Power supply settings]
 - [Counter Settings]
 - [Transmission mode]
 - [Input Information Transmission Method]
 - [Signal Tower Format]
 - [Periodic Transmission]
 - [Sensitivity for Determining Simultaneous Input]
 - [File Format for Received Data]
 - [Baud Rate]
 - [Data Length]
 - [Parity]
 - [Stop Bit]
 - * Click [Next] to fill out the fields on the next page.
 - * When collecting data with this product, set [Transmission mode] field to [Immediate transmission].
 - * For information about each item, refer to  section "7.1.1 WDT settings".
 - After setup is complete, click [Apply All Setting Changes].
- The settings are applied to the WDT.

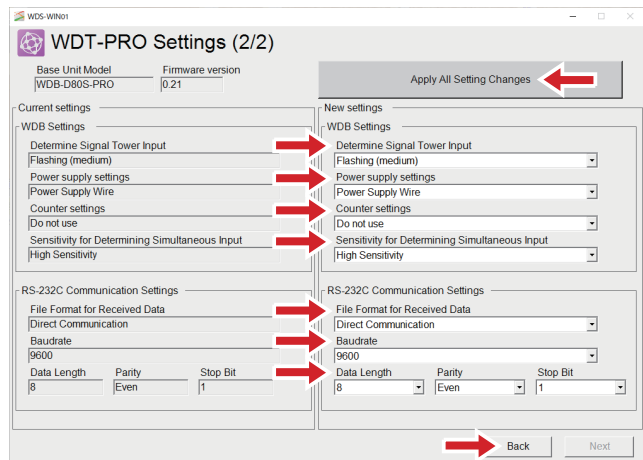
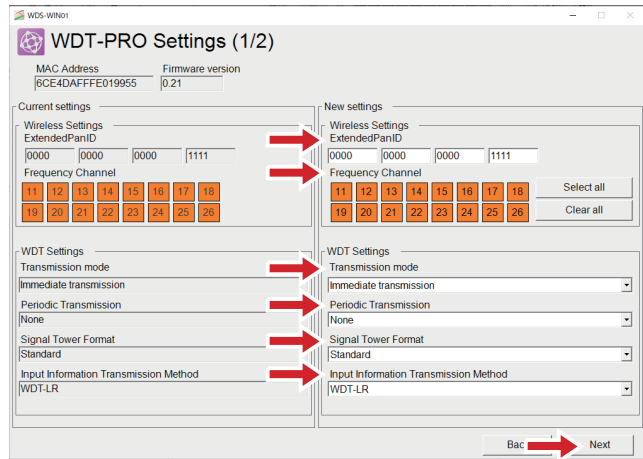

6. ■ Finish

(2) When using USB

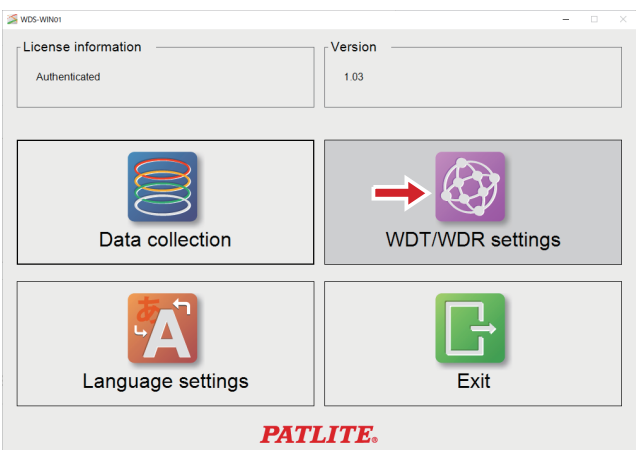
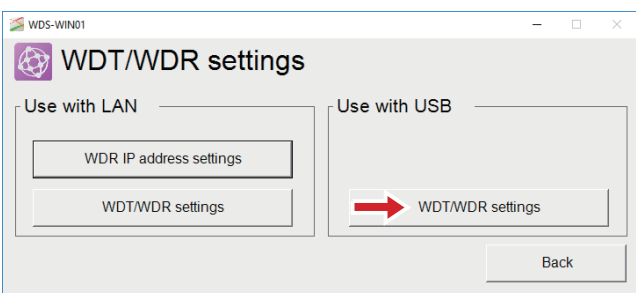
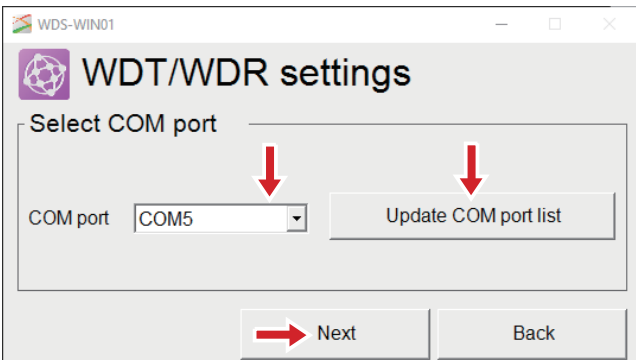
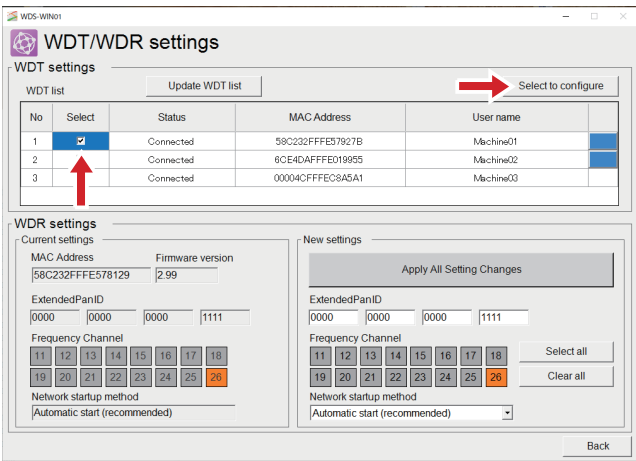
<p>1.</p> <ul style="list-style-type: none"> * Connect and power on the WDR and WDT as per the system configuration. Refer to section "2.3 (1) System Configuration". ■ From the Main menu, click [WDT/WDR settings]. 	 <p>The screenshot shows the main menu of the WDS-WIN01 software. It features four large buttons: 'Data collection', 'WDT/WDR settings' (highlighted with a red arrow), 'Language settings', and 'Exit'. The 'PATLITE' logo is visible at the bottom.</p>																				
<p>2.</p> <ul style="list-style-type: none"> ■ Under [Use with USB], click [WDT/WDR settings]. 	 <p>The screenshot shows the 'WDT/WDR settings' dialog box. It has two sections: 'Use with LAN' and 'Use with USB'. Under 'Use with USB', the 'WDT/WDR settings' button is highlighted with a red arrow. A 'Back' button is at the bottom right.</p>																				
<p>3.</p> <ul style="list-style-type: none"> ■ Click [Update COM port list]. ■ COM port numbers display in a pull-down list. <p>From the list, select the WDR COM port and click [Next].</p>	 <p>The screenshot shows the 'WDT/WDR settings' dialog box with the 'Select COM port' section. The 'COM port' dropdown menu is set to 'COM5'. The 'Update COM port list' button is highlighted with a red arrow. 'Next' and 'Back' buttons are at the bottom.</p>																				
<p>4.</p> <ul style="list-style-type: none"> ■ The [WDT list] under [WDT settings] shows the WDT units that are currently connected. <p>* It may take about 10 seconds to display the WDT list.</p> <ul style="list-style-type: none"> ■ Select the check boxes of WDT to set up, and click [Select to configure]. 	 <p>The screenshot shows the 'WDT/WDR settings' dialog box with the 'WDT settings' section expanded. It displays a table with columns for 'No.', 'Select', 'Status', 'MAC Address', and 'User name'. The first row is selected. The 'Select to configure' button is highlighted with a red arrow. Below the table are 'Current settings' and 'New settings' sections for configuration.</p> <table border="1" data-bbox="805 1624 1428 1747"> <thead> <tr> <th>No.</th> <th>Select</th> <th>Status</th> <th>MAC Address</th> <th>User name</th> </tr> </thead> <tbody> <tr> <td>1</td> <td><input checked="" type="checkbox"/></td> <td>Connected</td> <td>58C232FFFE57827B</td> <td>Machine01</td> </tr> <tr> <td>2</td> <td><input type="checkbox"/></td> <td>Connected</td> <td>8CE4DAFFED19955</td> <td>Machine02</td> </tr> <tr> <td>3</td> <td><input type="checkbox"/></td> <td>Connected</td> <td>00004CFFFC8A5A1</td> <td>Machine03</td> </tr> </tbody> </table>	No.	Select	Status	MAC Address	User name	1	<input checked="" type="checkbox"/>	Connected	58C232FFFE57827B	Machine01	2	<input type="checkbox"/>	Connected	8CE4DAFFED19955	Machine02	3	<input type="checkbox"/>	Connected	00004CFFFC8A5A1	Machine03
No.	Select	Status	MAC Address	User name																	
1	<input checked="" type="checkbox"/>	Connected	58C232FFFE57827B	Machine01																	
2	<input type="checkbox"/>	Connected	8CE4DAFFED19955	Machine02																	
3	<input type="checkbox"/>	Connected	00004CFFFC8A5A1	Machine03																	

5.**【For WDT Series】**

- Set up the following fields:
 - [ExtendedPanID]
 - [Frequency Channel]
 - [Determine Signal Tower Input]
 - [Power supply settings]
 - [Counter Settings]
 - [Transmission mode]
- * When collecting data with this product, set [Transmission mode] field to [Immediate transmission].
- * Some models and versions do not support [Counter Settings]. For information, refer to [☞](#) section "7.1.1 (3) ⑤ Counter Settings".
- * For information about each item, refer to [☞](#) section "7.1.1 WDT settings".
- After setup is complete, click [Apply All Setting Changes].

The settings are applied to the WDT.

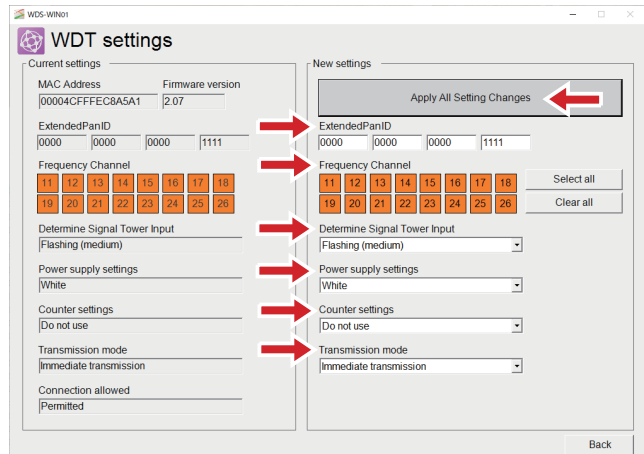

【For WDT-PRO Series】

- Set up the following fields:
 - [ExtendedPanID]
 - [Frequency Channel]
 - [Determine Signal Tower Input]
 - [Power supply settings]
 - [Counter Settings]
 - [Transmission mode]
 - [Input Information Transmission Method]
 - [Signal Tower Format]
 - [Periodic Transmission]
 - [Sensitivity for Determining Simultaneous Input]
 - [File Format for Received Data]
 - [Baud Rate]
 - [Data Length]
 - [Parity]
 - [Stop Bit]
 - * Click [Next] to fill out the fields on the next page.
 - * When collecting data with this product, set [Transmission mode] field to [Immediate transmission].
 - * For information about each item, refer to  section "7.1.1 WDT settings".
 - After setup is complete, click [Apply All Setting Changes].
- The settings are applied to the WDT.

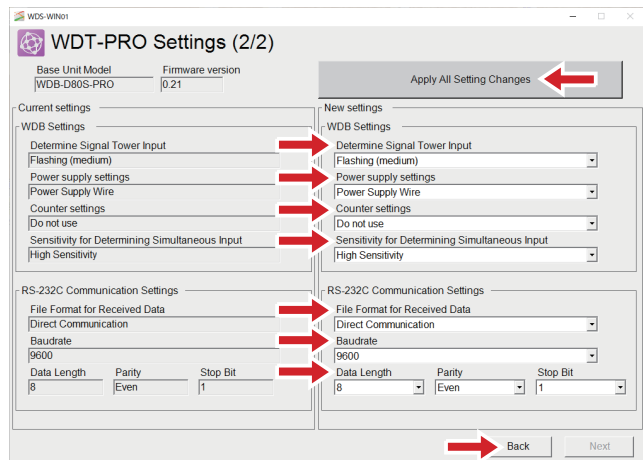
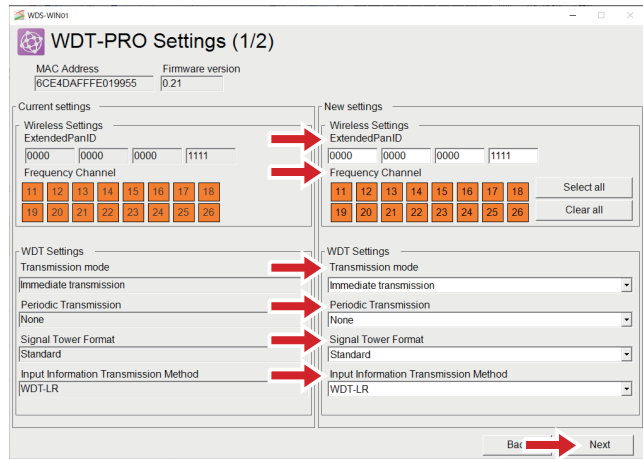

6. ■ Finish

6.1.3 WDR setup

CAUTION	
 Prohibited	◆ When there are multiple WDR in your system, do not use duplicate ExtendedPanID values. The product may not operate properly.

(1) When using LAN

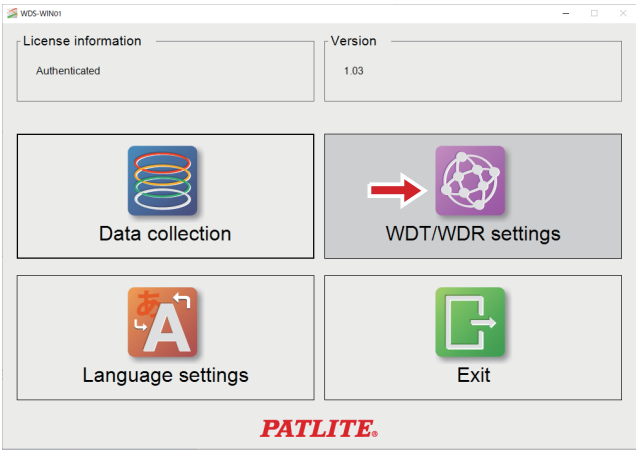
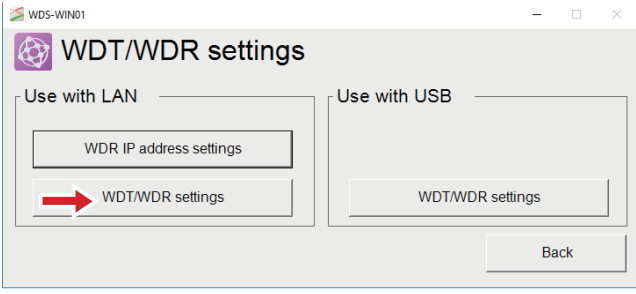
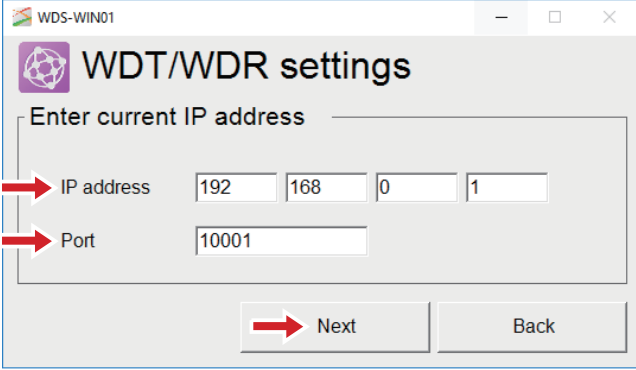
<p>1.</p> <ul style="list-style-type: none"> ■ From the Main menu, click [WDT/WDR settings]. 	
<p>2.</p> <ul style="list-style-type: none"> ■ Under [Use with LAN], click [WDT/WDR settings]. 	
<p>3.</p> <ul style="list-style-type: none"> ■ Enter the current IP address of the connected WDR. · If you have not changed the WDR IP address from its default setting, enter 192.168.0.1. * On the WD PRO receiver, the initial value is 192.168.10.1. · If you did not change the port number in procedure "6.1.1 (2)", do not change its default value of 10001. · If you changed the port number in procedure "6.1.1 (2)", enter the same port number. ■ Click [Next]. 	

4. ■ Click [Next].

* This step is for WD PRO receivers only. For WDR, skip step 4 and go to step 5.

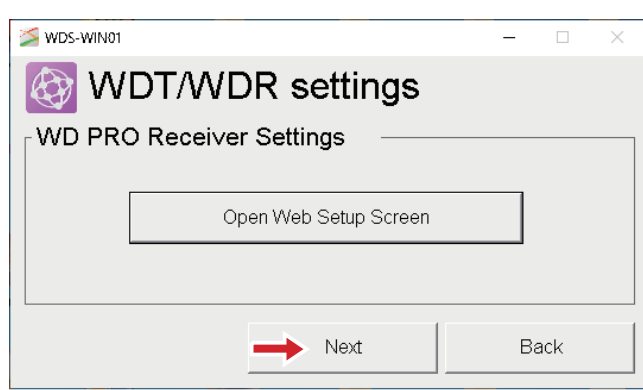

5. ■ Set up the following fields:

- [ExtendedPanID]
- [Frequency Channel]

Set up the respective settings above.

- Under [Network startup method], we recommend selecting [Automatic start].

■ Click [Apply All Setting Changes].

* For information on settings, refer to section "7.1.3 WDR settings (Wireless settings)".

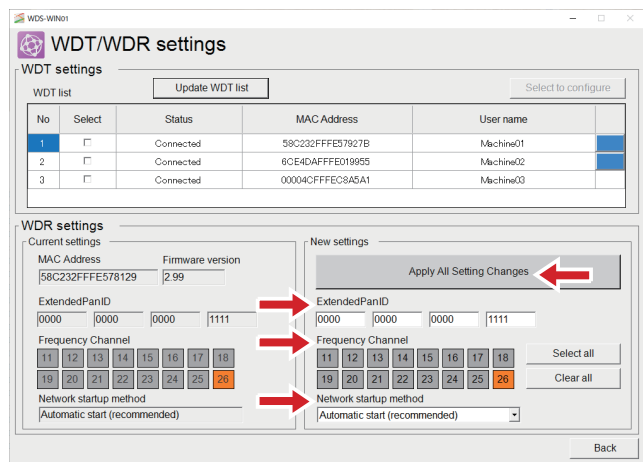

6. ■ Finish

(2) When using USB

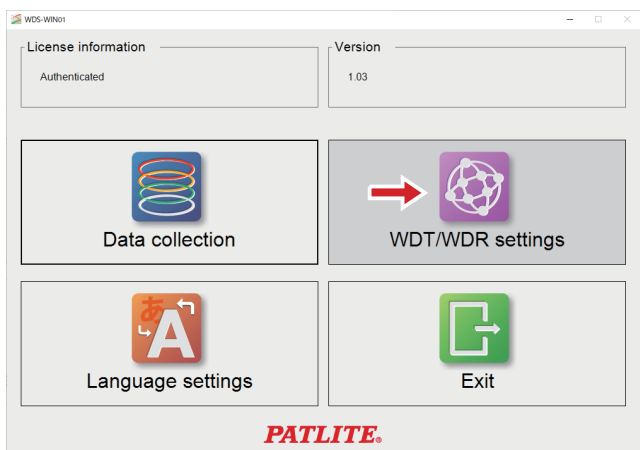
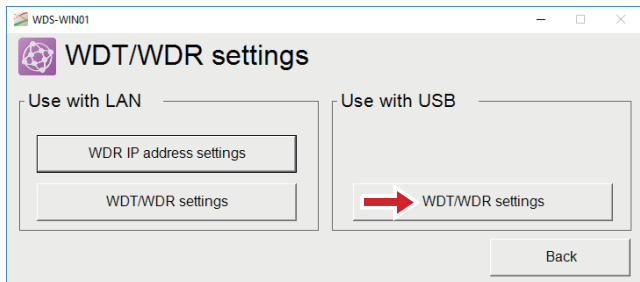
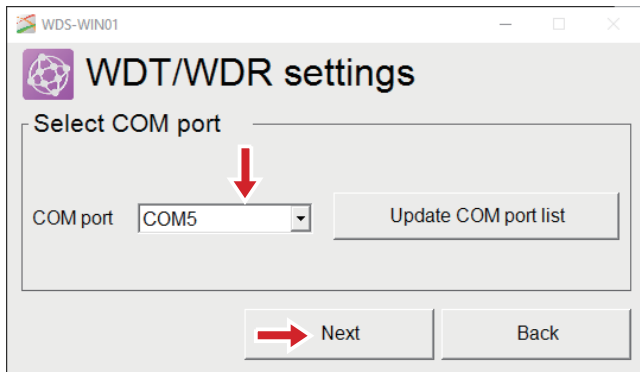
<p>1.</p> <ul style="list-style-type: none"> From the Main menu, click [WDT/WDR settings]. 	 <p>The screenshot shows the main menu of the WDS-WIN01 software. It includes fields for 'License information' (Authenticated) and 'Version' (1.03). There are four main buttons: 'Data collection', 'WDT/WDR settings' (highlighted with a red arrow), 'Language settings', and 'Exit'. The 'PATLITE' logo is at the bottom.</p>
<p>2.</p> <ul style="list-style-type: none"> Under [Use with USB], click [WDT/WDR settings]. 	 <p>The screenshot shows the 'WDT/WDR settings' dialog box. It has two sections: 'Use with LAN' and 'Use with USB'. Under 'Use with LAN', there are buttons for 'WDR IP address settings' and 'WDT/WDR settings'. Under 'Use with USB', there is a 'WDT/WDR settings' button highlighted with a red arrow and a 'Back' button at the bottom right.</p>
<p>3.</p> <ul style="list-style-type: none"> Click [Update COM port list]. COM port numbers display in a pull-down list. <p>From the list, select the WDR COM port and click [Next].</p>	 <p>The screenshot shows the 'WDT/WDR settings' dialog box with the 'Select COM port' section. A red arrow points to the 'Update COM port list' button. Below it, the 'COM port' dropdown menu is open, showing 'COM5'. At the bottom, there are 'Next' and 'Back' buttons, with a red arrow pointing to the 'Next' button.</p>

- 4.**
- Set up the following fields:
 - [ExtendedPanID]
 - [Frequency Channel]
- Set up the respective settings above.
- * Under [Network startup method], we recommend selecting [Automatic start].
 - Click [Apply All Setting Changes].
 - * For information on settings, refer to section "7.1.3 WDR settings (Wireless settings)".

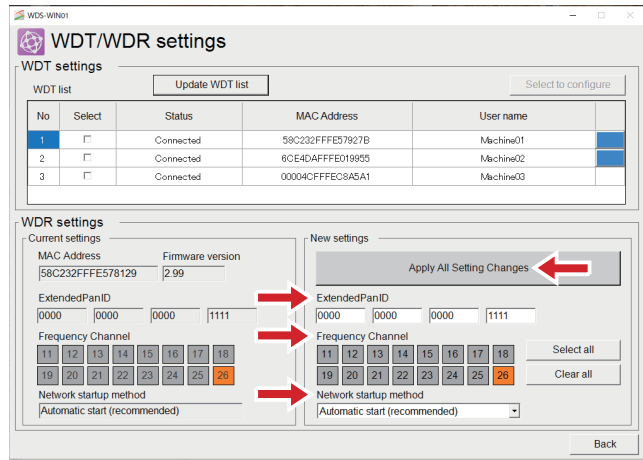

- 5.**
- Finish

6.1.4 Configure WDR Host Collaboration Function (WD PRO receiver only)

⚠ CAUTION

Prohibited

◆ Set up possible only when using WD PRO receiver on LAN. Set up not possible when used with USB.

- 1.**
- From the Main menu, click [WDT/WDR settings].

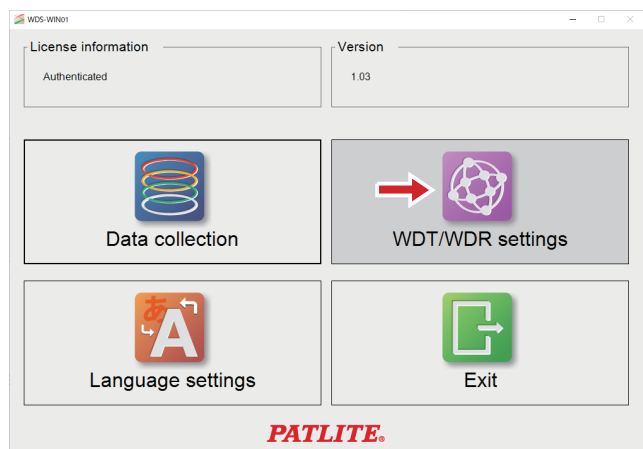

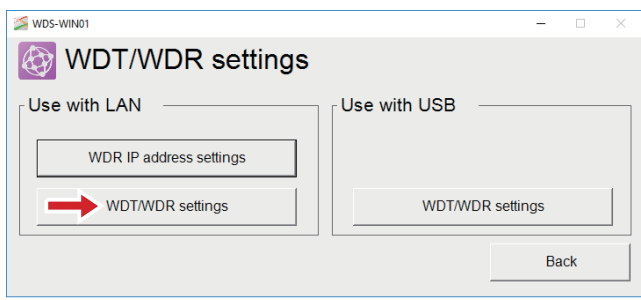
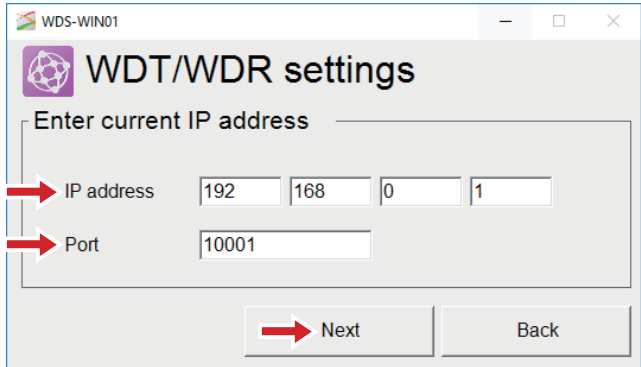
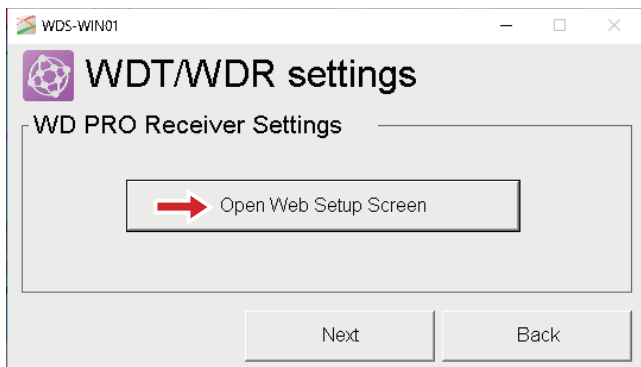
<p>2.</p> <ul style="list-style-type: none"> ■ Under [Use with LAN], click [WDT/WDR settings]. 	
<p>3.</p> <ul style="list-style-type: none"> ■ Enter the current IP address of the connected WDR. • If you have not changed the WDR IP address from its default setting, enter 192.168.10.1. • If you did not change the port number in procedure "6.1.1 (2)", do not change its default value of 10001. • If you changed the port number in procedure "6.1.1 (2)", enter the same port number. ■ Click [Next]. 	
<p>4.</p> <ul style="list-style-type: none"> ■ Click [Open Web Setup Screen]. 	

- 5.**
- The browser starts and the login screen appears.
 - Enter the user name and password.
- When you log in to the WDR WEB screen for the first time, the user name and password setting screen will be displayed depending on the firmware version, so be sure to set the user name and password.
- ※ If the firmware version is 1.02 or earlier, the initial user name and password are "patlite" and "patlite".
 - Click [Login].

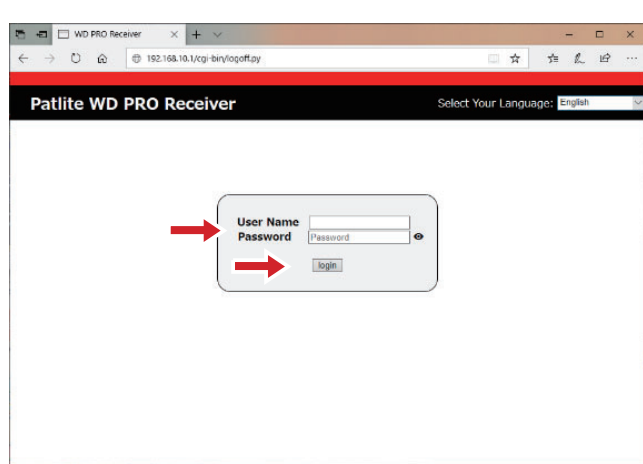

- 6.**
- Items you can set are below.
 - [Socket Communication]
 - [Database Communication]
 - [Modbus/TCP Communication]
 - * Set as required by the application.
 - For information on settings, refer to section 7.3.3 in the "[WDT- □ LR-Z2/WDR-L(E)-Z2-PRO(-L) Instruction Manual]".

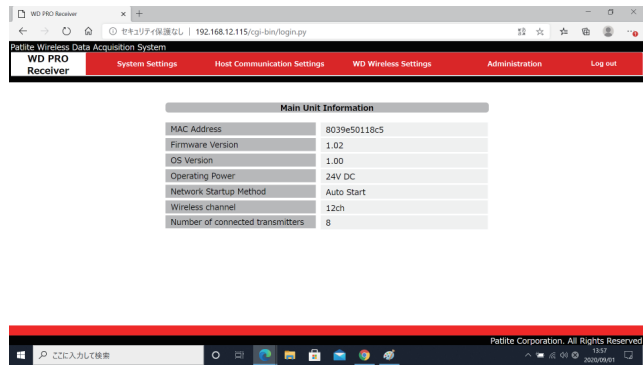

- 7.**
- Finish



6.2 Data collection

6.2.1 License authentication

⚠ CAUTION	
⚠	<ul style="list-style-type: none"> ◆ Store the license card for future reference. ◆ After uninstalling this product, license authentication is required when re-installing.

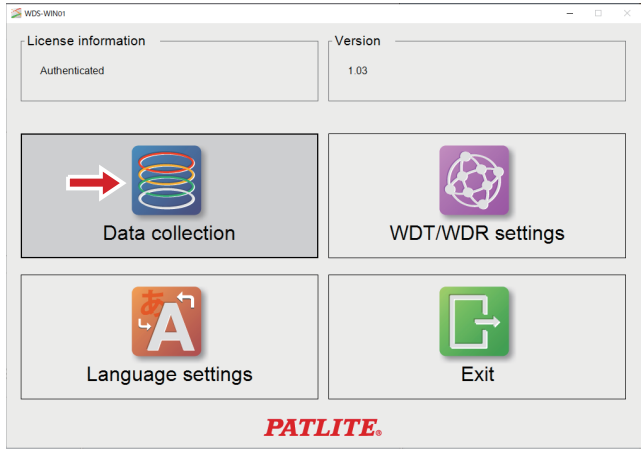
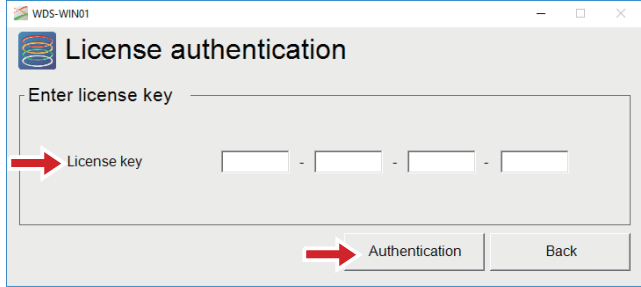
<p>1. ■ From the Main menu, click [Data collection].</p>	
<p>2. ■ Run license authentication.</p> <p>Enter the 17-digit license key provided with this product and click [Authentication].</p>	
<p>3. ■ Finish</p>	<p style="text-align: center;">-</p>

6.2.2 Data save destination and CSV file format settings

(1) Setting the data save destination

CAUTION	
	◆ You cannot output data collection files to network drives and external storage devices such as SD cards and USB memory.

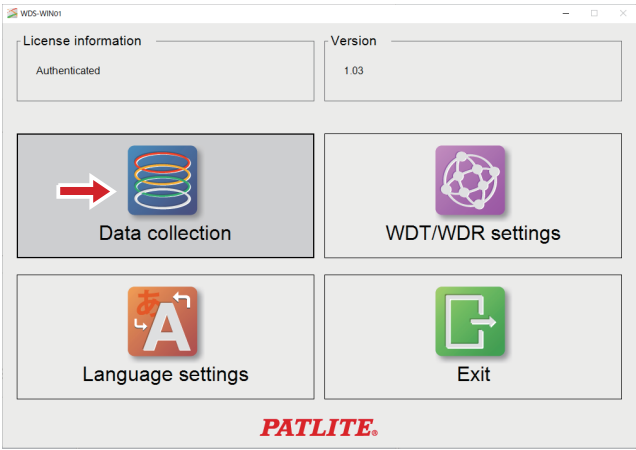
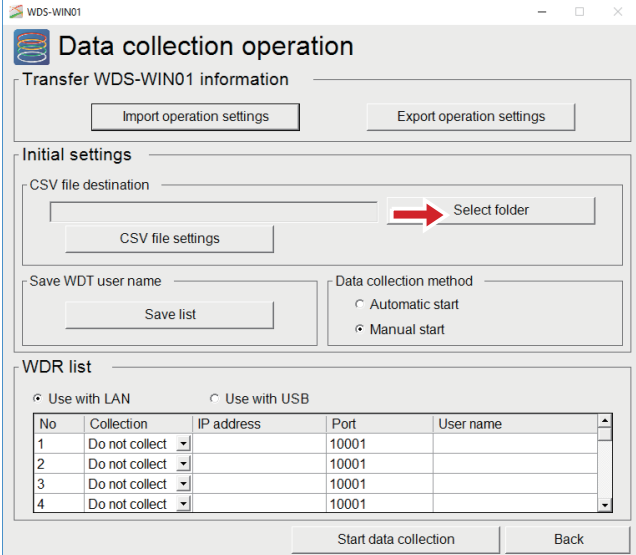
1.	<ul style="list-style-type: none"> ■ From the Main menu, click [Data collection]. 	
2.	<ul style="list-style-type: none"> ■ Set up the save destination for CSV data. Under [Initial settings] click [Select folder]. 	

- 3.**
- Define the destination folder.
 - Click [OK].

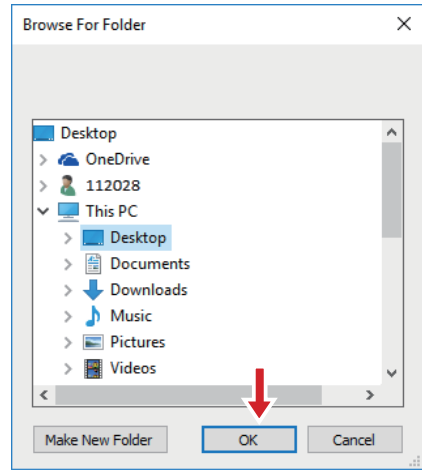

- 4.**
- Finish

—

(2) CSV file format settings

1. ■ Under [Data collection operation] click [CSV file settings].

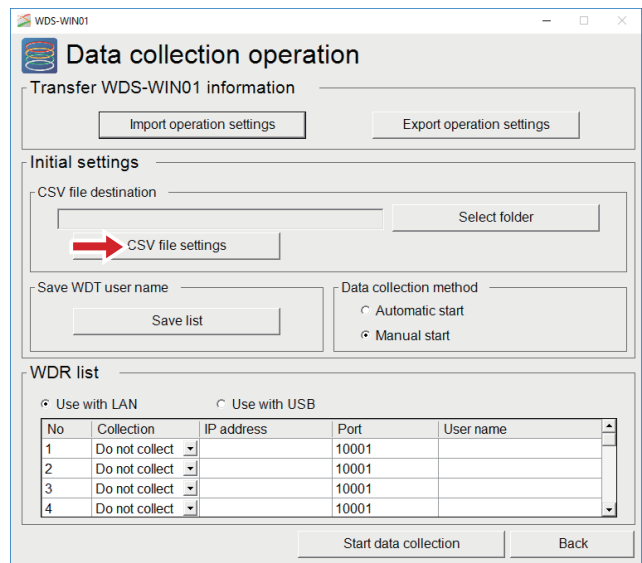

2. ■ Select one of the options under [File creation method].
- [Common]
 - [Common (file name)]
 - [Per WDR]
 - [Per WDT]

- Select one of the options under [File division method].

- [Divide by date]
- [Divide by time]
- [Divide by file size]
- [Do not divide]

- Enable or disable [On dividing, output information].

Check the box to add Signal Tower Information when splitting files.

* For information on settings, refer to section "7.2.1 Initial settings (save as CSV file)".

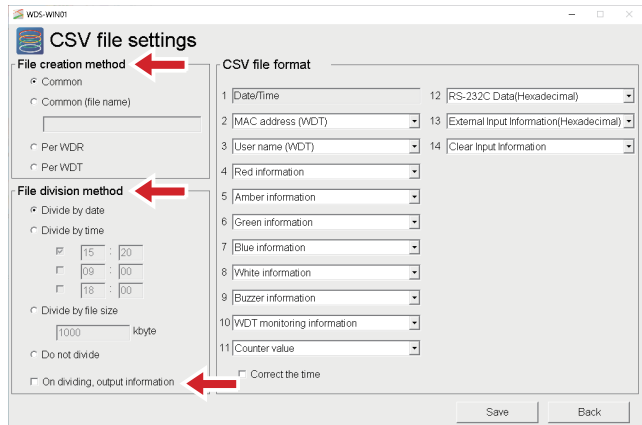

- 3.** ■ Set up the [CSV file format].
- Select up to 13 properties to include in the CSV file.
- * Fields within your list of selected fields cannot be left at [No settings].
 - Select to enable or disable [Correct the time].
- Check the box to enable time correction, uncheck to disable.
- * For information on settings, refer to section "7.2.1 Initial settings (save as CSV file)".

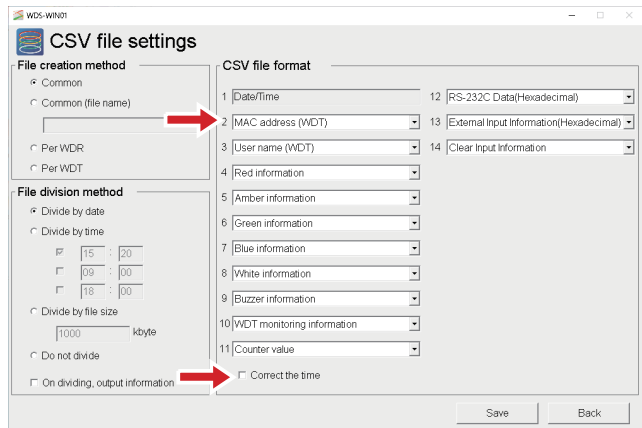

- 4.** ■ After setup is complete, click [Save].

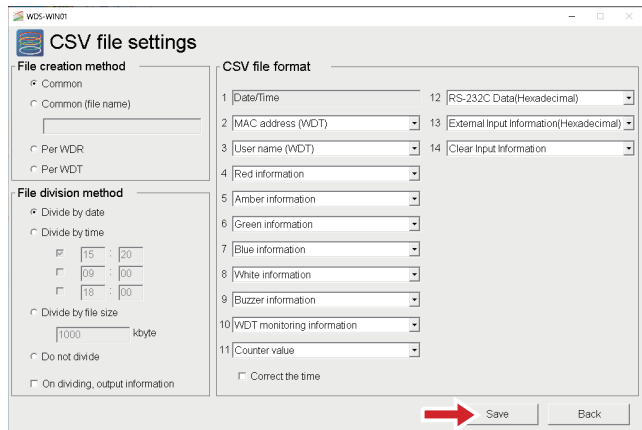

- 5.** ■ Click [Yes].

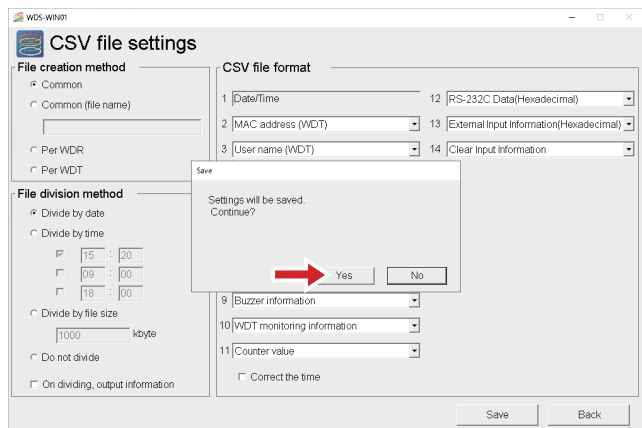

- 6.** ■ Finish

6.2.3 Save WDT user name

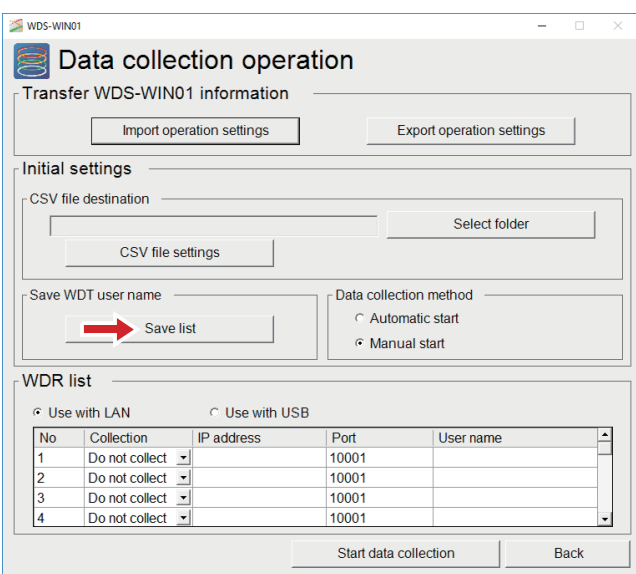
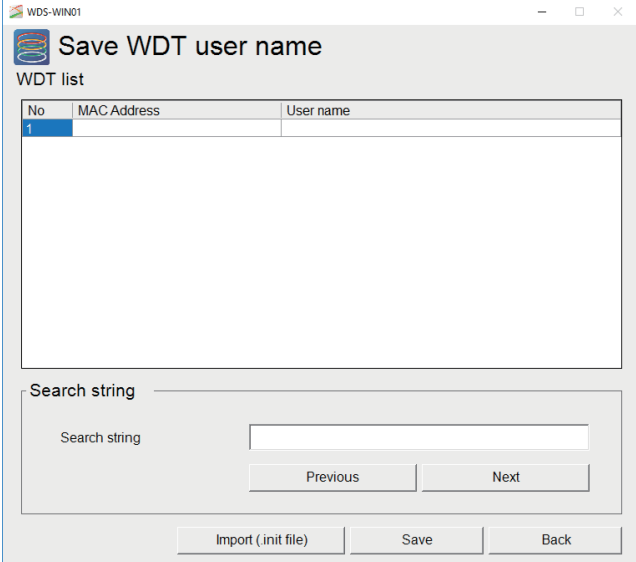
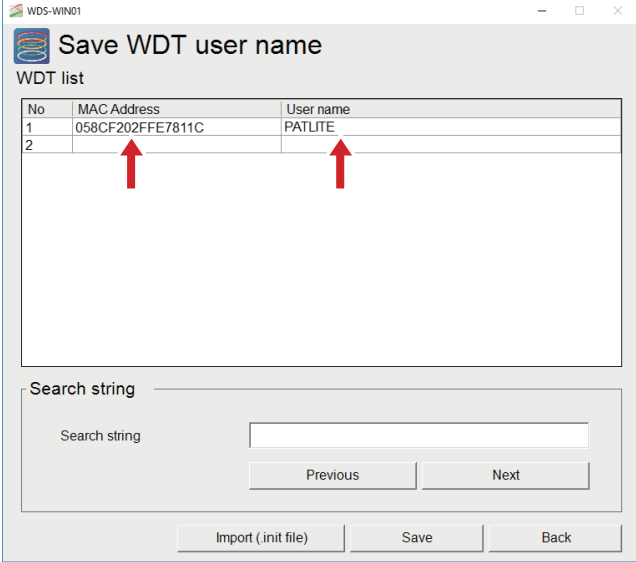
<p>1.</p> <ul style="list-style-type: none"> Under [Save WDT user name], click [Save list]. 	 <p>The screenshot shows the 'Data collection operation' window. In the 'Initial settings' section, the 'Save WDT user name' area has a red arrow pointing to the 'Save list' button. Other visible elements include 'Import operation settings', 'Export operation settings', 'CSV file destination', 'Select folder', 'Data collection method' (Automatic start and Manual start), and a 'WDR list' table with columns: No, Collection, IP address, Port, User name.</p>
<p>2.</p> <ul style="list-style-type: none"> [Save WDT user name] screen appears. 	 <p>The screenshot shows the 'Save WDT user name' window. The 'WDT list' table is empty with columns: No, MAC Address, User name. Below the table is a 'Search string' section with a text input field and 'Previous' and 'Next' buttons. At the bottom are 'Import (init file)', 'Save', and 'Back' buttons.</p>
<p>3.</p> <ul style="list-style-type: none"> Enter the following fields for the WDT that you are registering. <ul style="list-style-type: none"> MAC Address User name 	 <p>The screenshot shows the 'Save WDT user name' window. The 'WDT list' table now has two rows. The first row has '1' in the 'No' column, '058CF202FFE7811C' in the 'MAC Address' column, and 'PATLITE' in the 'User name' column. Red arrows point to these two fields. The rest of the interface is the same as in step 2.</p>

- 4.** ■ To delete entered content, right click the row you want to delete and select [Delete].
- * If you select [Delete all], all rows will be deleted.

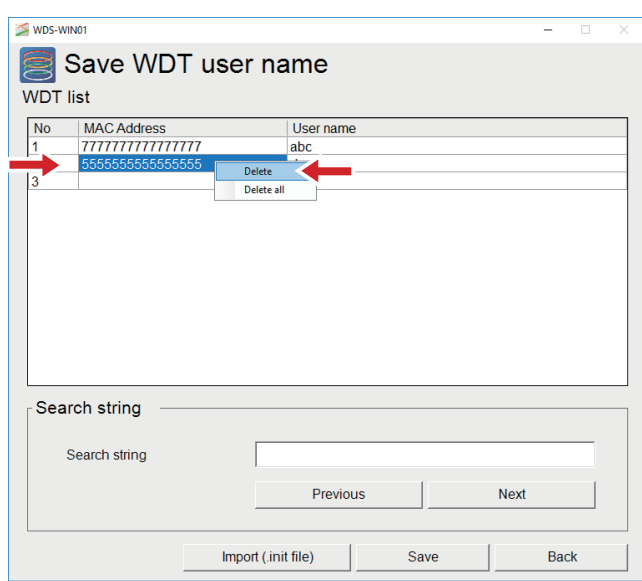

- 5.** ■ After setup is complete, click [Save].

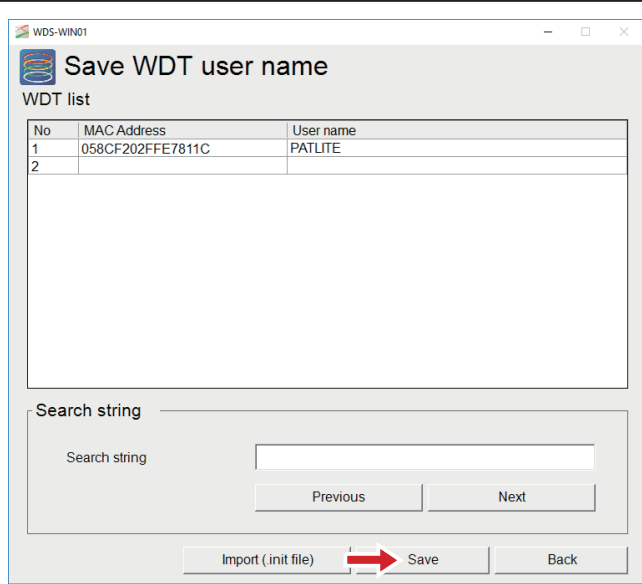

- 6.** ■ Click [Yes].

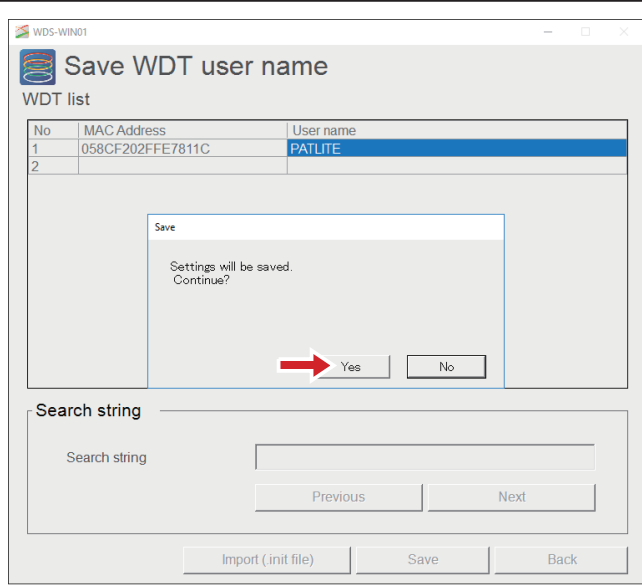

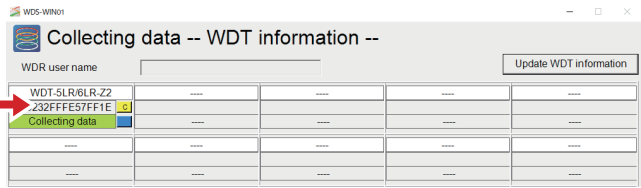
<p>7.</p> <ul style="list-style-type: none"> ■ The saved user name should appear on the [Collecting data --WDT information--] screen. 	
<p>8.</p> <ul style="list-style-type: none"> ■ Finish 	-

6.2.4 Registering WDR and starting collection

(1) When using LAN

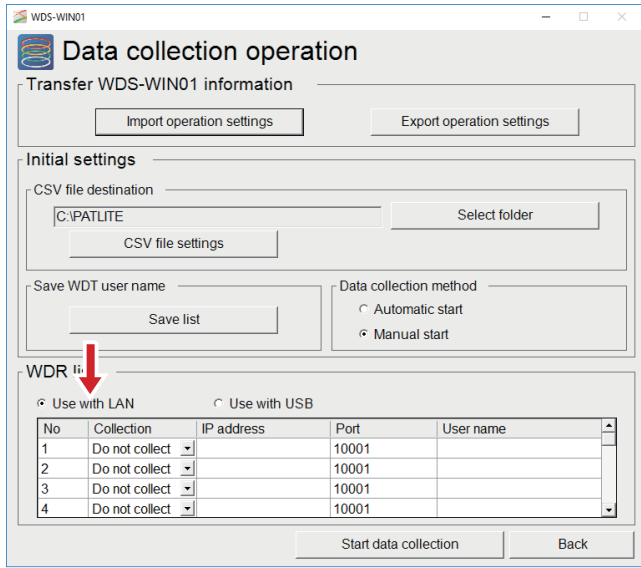
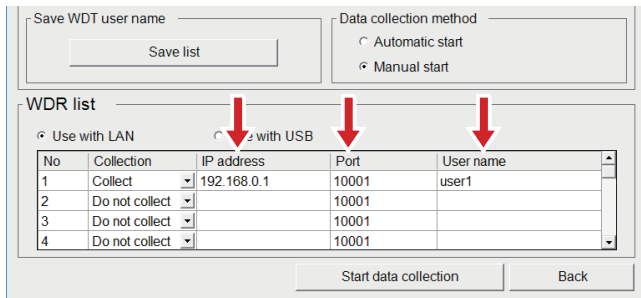
<p>1.</p> <ul style="list-style-type: none"> ■ Under [WDR list] select [Use with LAN]. 	
<p>2.</p> <ul style="list-style-type: none"> ■ Under [WDR list], use the keyboard to enter the following fields: <ul style="list-style-type: none"> • [IP address] • [User name] • If you did not change the port number in procedure "6.1.1 (2)", do not change its default value of 10001. * When entering the IP address, include the period separators. * Up to 20 WDR units can be registered. 	

- 3.**
- From the [WDR list], locate the WDR unit that you will collect data from.
 - Under [Collection], select [Collect].
 - Click [Start data collection].

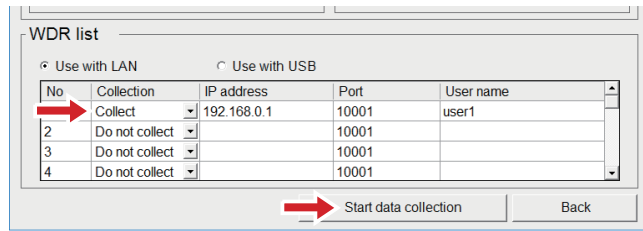

- 4.**
- The [Collecting data --WDR information--] window appears, and the green [Collecting data] tab indicates that data collection is running.

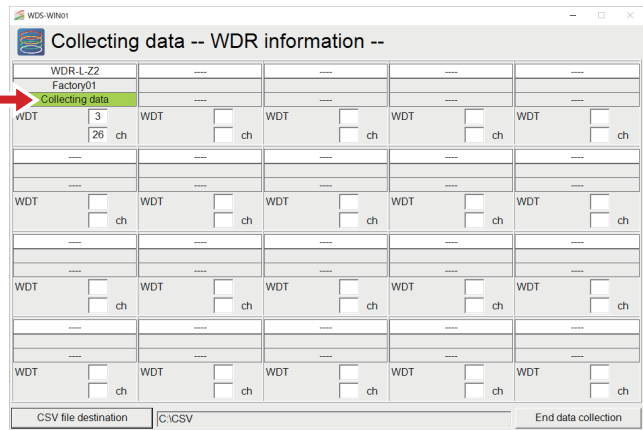

- 5.**
- Finish

(2) When using USB

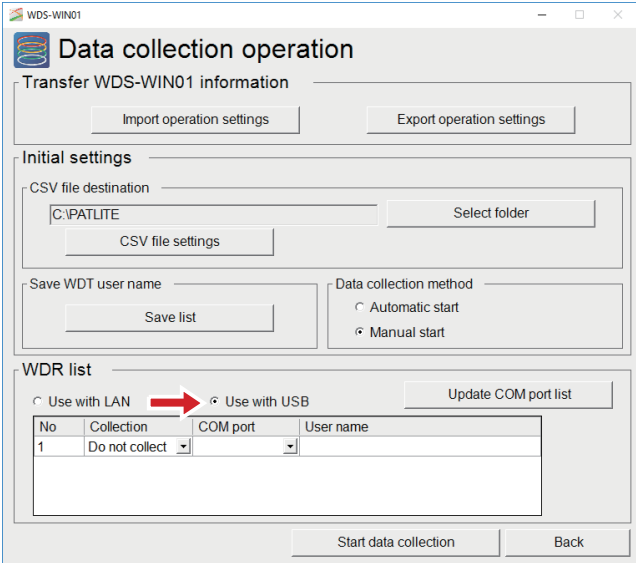
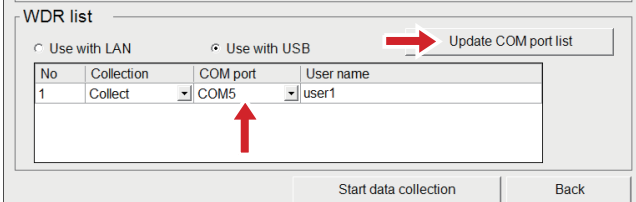
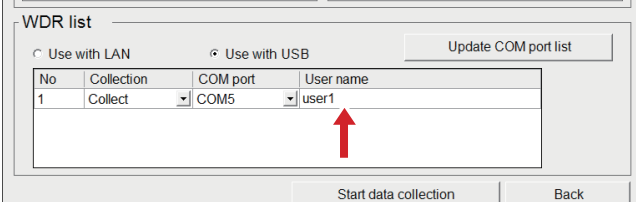
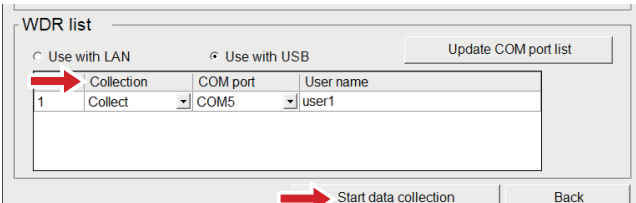
<p>1.</p> <ul style="list-style-type: none"> Under [WDR list] select [Use with USB]. 	
<p>2.</p> <ul style="list-style-type: none"> Click [Update COM port list]. COM port numbers display in a pull-down list. <p>From the menu, select the COM port of the WDR that you are collecting data from.</p>	
<ul style="list-style-type: none"> Enter a user name under [User name]. <p>* When using with USB, only one WDR unit can be submitted at a time for data collection.</p>	
<p>3.</p> <ul style="list-style-type: none"> In the drop down menu under [Collection], select [Collect]. Click [Start data collection]. 	

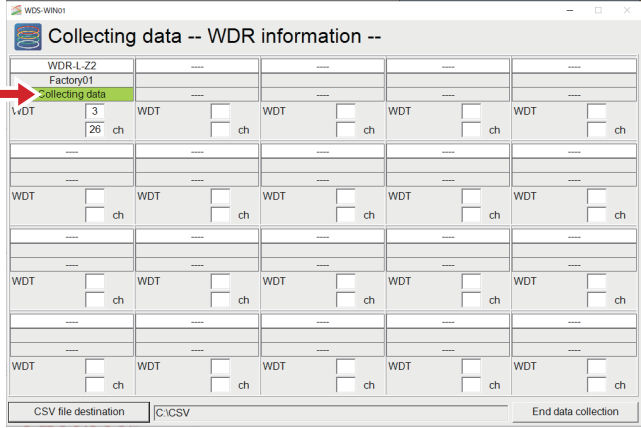
<p>4.</p>	<ul style="list-style-type: none"> The [Collecting data --WDR information--] window appears, and the green [Collecting data] tab indicates that data collection is running. 	
<p>5.</p>	<ul style="list-style-type: none"> Finish 	<p>—</p>

6.2.5 Checking the data save destination

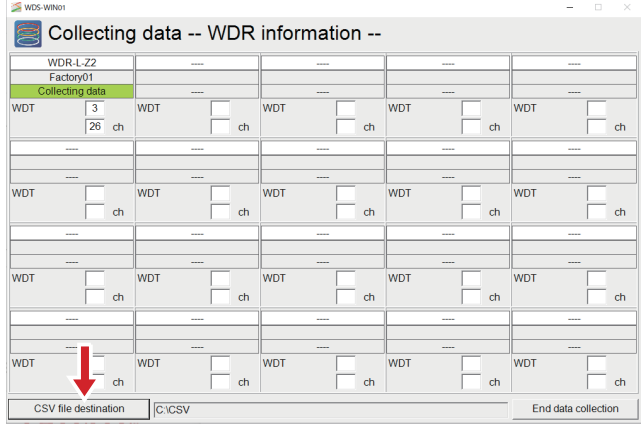
<p>1.</p>	<ul style="list-style-type: none"> At the bottom of the [Collecting data -- WDR Information --] screen, click [CSV file destination]. 	
<p>2.</p>	<ul style="list-style-type: none"> Explorer displays the data destination folder. Check that collected data is saved in that location. 	
<p>3.</p>	<ul style="list-style-type: none"> Finish 	<p>—</p>

6.2.6 Checking communication status of WDT while collecting data

1. ■ Click on the cell that displays the WDR status (indicated by arrow).

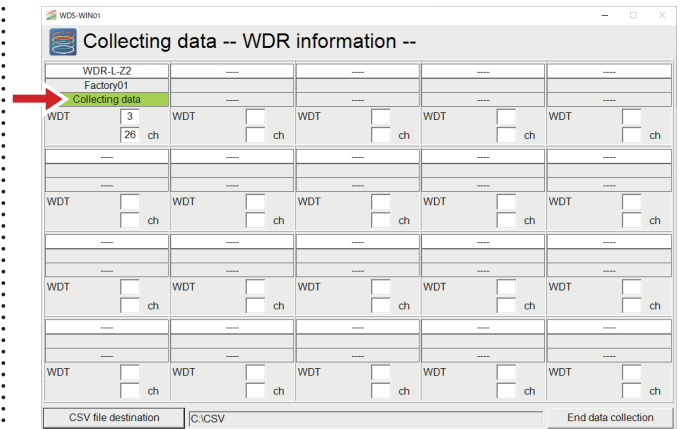

2. ■ The [Collecting data -- WDT information --] screen should appear.

* Even if the transmitter that is connected is WDT-4LR-Z2, "WDT-5LR/6LR-Z2" is displayed.

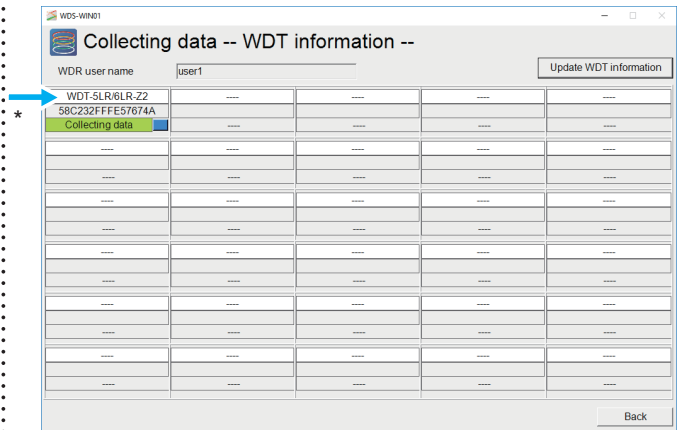

3. ■ Finish

6.2.7 Stopping data collection

1. ■ At the bottom of the [Collecting data -- WDR Information --] screen, click [End data collection].

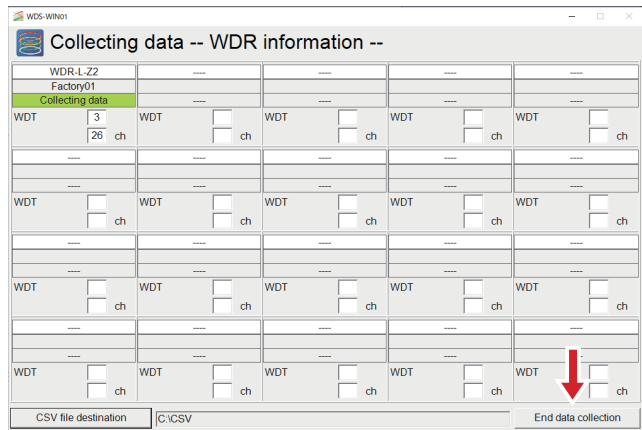

2. ■ The [Data collection will end. Continue?] message displays. Click [Yes].

* Refer to the caution on the next page for steps on how you can end data collection.

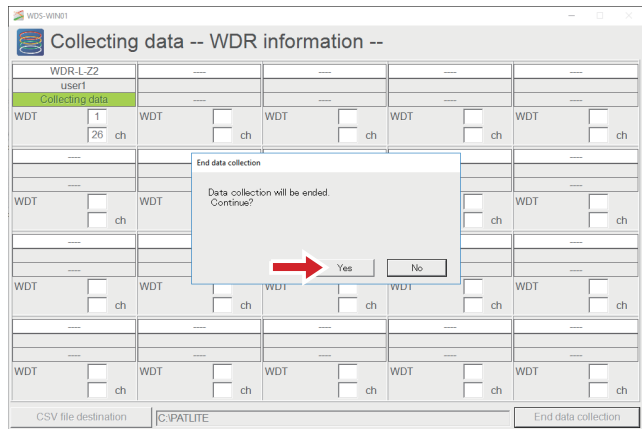

3. ■ The [Data collection operation] screen appears, and data collection ends.

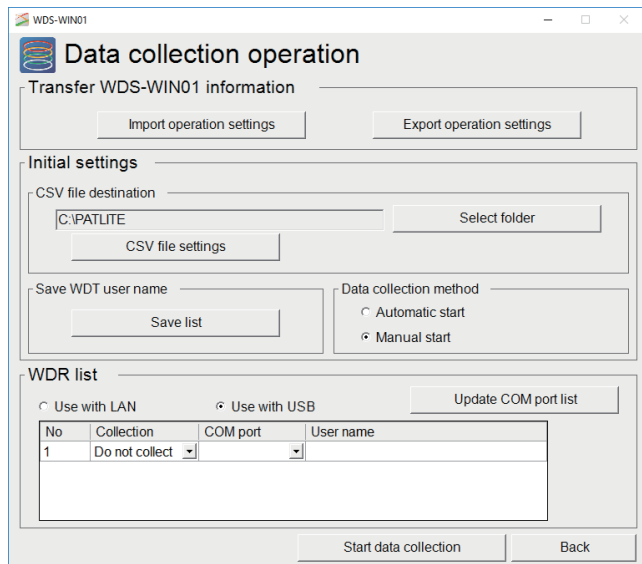

4. ■ Finish

 CAUTION



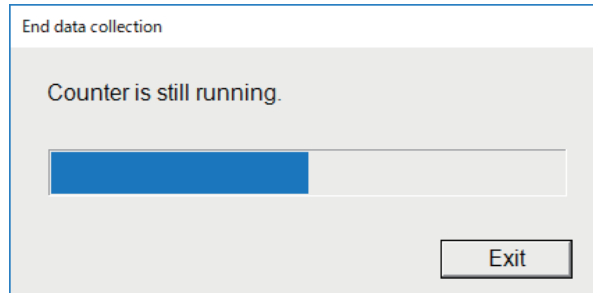

- ◆ Even after clicking [yes] in the warning message [Data collection will end. Continue?], ending data collection could take some time when there are multiple WDT units connected. In this case, the following screen will appear. Clicking [Exit] will force the data collection to quit. Note that any counter values after clicking [Exit] will not be collected.



- ◆ After starting data collection, wait at least one minute to stop collection. Counter values that are collected during this period may not output to CSV properly.

6.2.8 Save settings and return

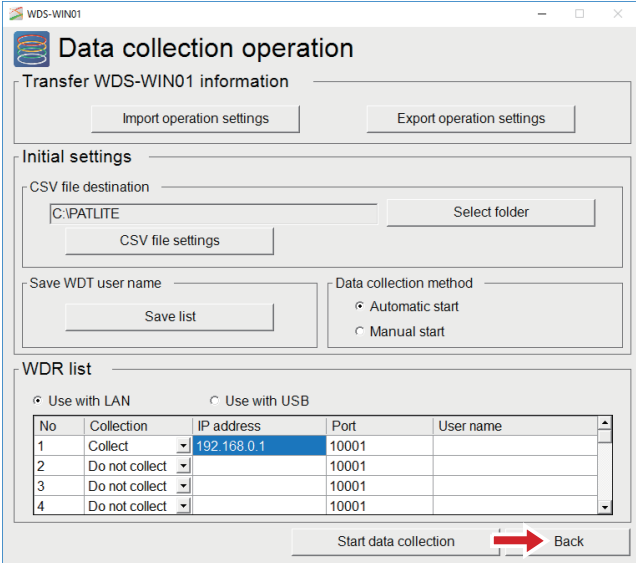
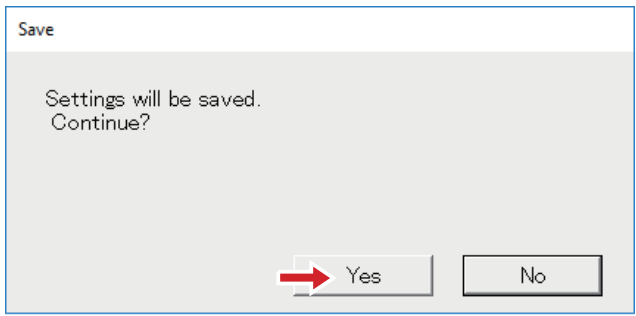
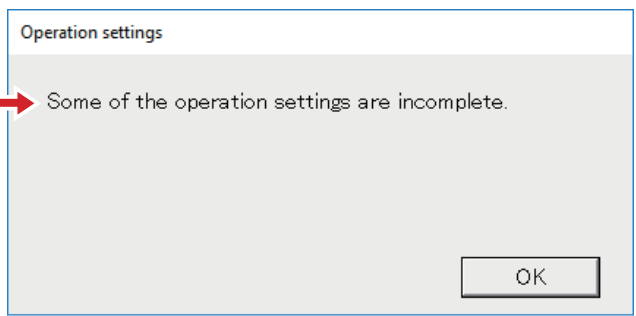
(1) When WDR is connected properly

<p>1.</p> <ul style="list-style-type: none"> ■ Connect WDR. 	
<p>2.</p> <ul style="list-style-type: none"> ■ Display [Data collection operation]. ■ Enter fields as needed. ■ Click [Back]. 	
<p>3.</p> <ul style="list-style-type: none"> ■ In the [Save] dialog box click [Yes]. 	
<p>4.</p> <p>* If the warning message "Some of the operation settings are incomplete" appears, refer to the possible issues below:</p>	
<p>① CSV file destination is not set up.</p> <p>→ Set up the file destination.</p> <p>Refer to  section "6.2.2 (1) Setting the data save destination".</p>	

② WDR is not connected properly.

→ Connect WDR properly.

→ If you cannot connect WDR properly,

Refer to  section "6.2.8 (2) When WDR is not connected properly".

③ WDR is connected properly to LAN but other settings are incomplete.

→ Follow the steps below.

◆ Under [WDR list], select [Use with USB].

◆ Change [Collection] to [Do not collect].

◆ Under [WDR list], select [Use with LAN].

◆ Enter the IP address of the WDR.

◆ Under [Collection], choose [Collect].

◆ Click [Back].

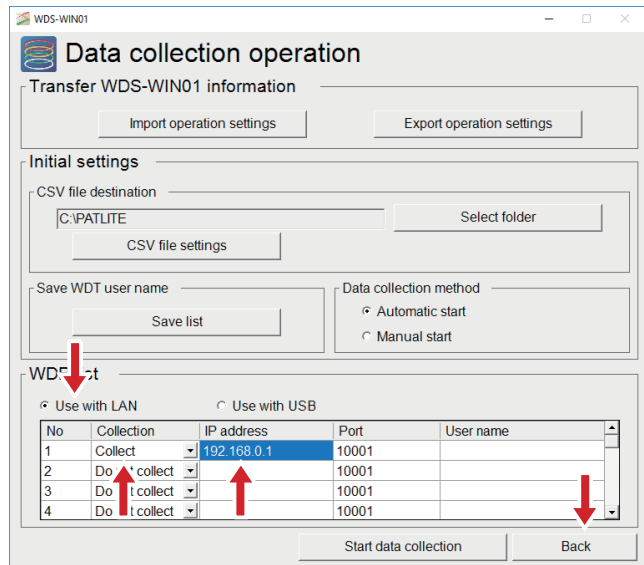
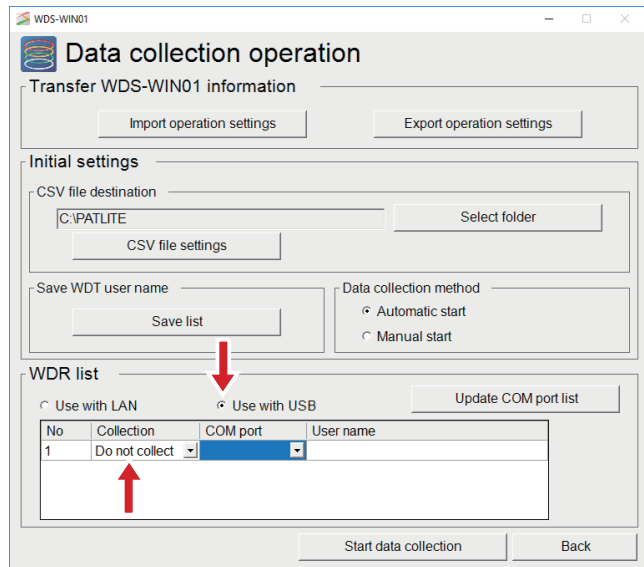

④ When WDR is connected properly via USB but other settings are incomplete.

→ Follow the steps below.

- ◆ Under [WDR list], select [Use with USB].
- ◆ Click [Update COM port list].
- ◆ Select the [COM port].
- ◆ Change [Collection] to [Collect].
- ◆ Click [Back].

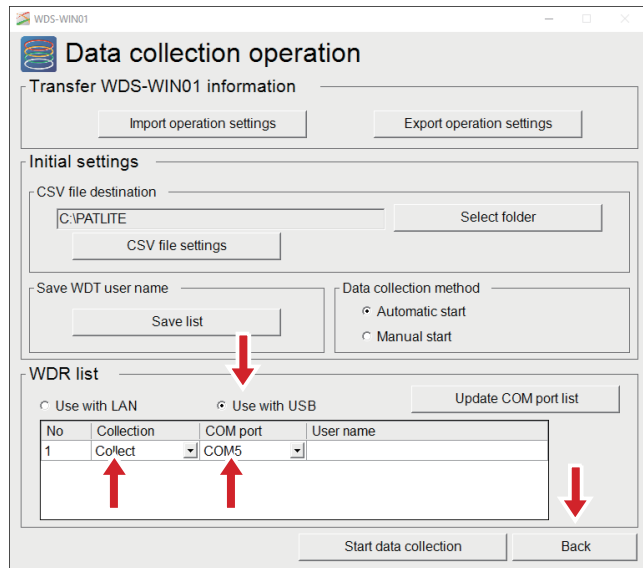

5. ■ Finish

(2) When WDR is not connected properly

<p>1.</p> <ul style="list-style-type: none"> ■ Display [Data collection operation]. ■ Under [WDR list], select [Use with USB]. ■ Change [Collection] to [Do not collect]. 	<p>WDS-WIN01</p> <h3>Data collection operation</h3> <p>Transfer WDS-WIN01 information</p> <p>Import operation settings Export operation settings</p> <p>Initial settings</p> <p>CSV file destination: C:\PATLITE Select folder</p> <p>CSV file settings</p> <p>Save WDT user name: Save list</p> <p>Data collection method: <input checked="" type="radio"/> Automatic start <input type="radio"/> Manual start</p> <p>WDR list</p> <p><input type="radio"/> Use with LAN <input checked="" type="radio"/> Use with USB Update COM port list</p> <table border="1"> <thead> <tr> <th>No</th> <th>Collection</th> <th>COM port</th> <th>User name</th> </tr> </thead> <tbody> <tr> <td>1</td> <td>Do not collect</td> <td></td> <td></td> </tr> </tbody> </table> <p>Start data collection Back</p>	No	Collection	COM port	User name	1	Do not collect																			
No	Collection	COM port	User name																							
1	Do not collect																									
<p>2.</p> <ul style="list-style-type: none"> ■ Under [WDR list], select [Use with LAN]. ■ Enter the IP address. ■ Under [Collection], choose [Collect]. ■ Click [Back]. 	<p>WDS-WIN01</p> <h3>Data collection operation</h3> <p>Transfer WDS-WIN01 information</p> <p>Import operation settings Export operation settings</p> <p>Initial settings</p> <p>CSV file destination: C:\PATLITE Select folder</p> <p>CSV file settings</p> <p>Save WDT user name: Save list</p> <p>Data collection method: <input checked="" type="radio"/> Automatic start <input type="radio"/> Manual start</p> <p>WDR list</p> <p><input checked="" type="radio"/> Use with LAN <input type="radio"/> Use with USB</p> <table border="1"> <thead> <tr> <th>No</th> <th>Collection</th> <th>IP address</th> <th>Port</th> <th>User name</th> </tr> </thead> <tbody> <tr> <td>1</td> <td>Collect</td> <td>192.168.0.1</td> <td>10001</td> <td></td> </tr> <tr> <td>2</td> <td>Do not collect</td> <td></td> <td>10001</td> <td></td> </tr> <tr> <td>3</td> <td>Do not collect</td> <td></td> <td>10001</td> <td></td> </tr> <tr> <td>4</td> <td>Do not collect</td> <td></td> <td>10001</td> <td></td> </tr> </tbody> </table> <p>Start data collection Back</p>	No	Collection	IP address	Port	User name	1	Collect	192.168.0.1	10001		2	Do not collect		10001		3	Do not collect		10001		4	Do not collect		10001	
No	Collection	IP address	Port	User name																						
1	Collect	192.168.0.1	10001																							
2	Do not collect		10001																							
3	Do not collect		10001																							
4	Do not collect		10001																							
<p>3.</p> <ul style="list-style-type: none"> ■ In the [Save] dialog box click [Yes]. 	<p>Save</p> <p>Settings will be saved. Continue?</p> <p>Yes No</p>																									
<p>4.</p> <ul style="list-style-type: none"> ■ Finish 	<p>—</p>																									

(3) Returning without saving settings

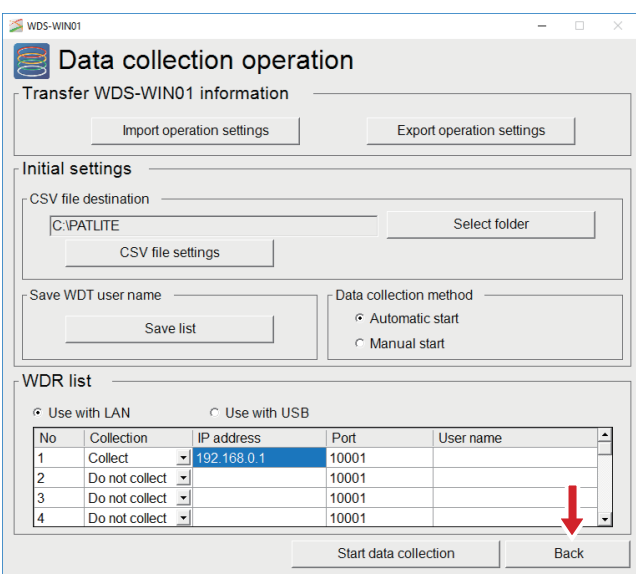
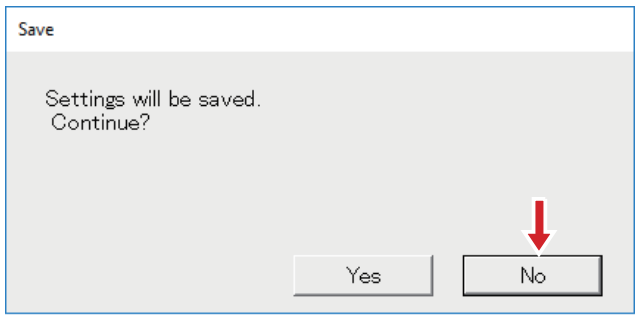
<p>1. ■ At the bottom right of the [Data collection operation] screen, click [Back].</p>	
<p>2. ■ In the [Save] dialog box click [No].</p>	
<p>3. ■ Finish</p>	<p style="text-align: center;">-</p>

6.3 Exporting and importing settings information

6.3.1 Exporting settings information

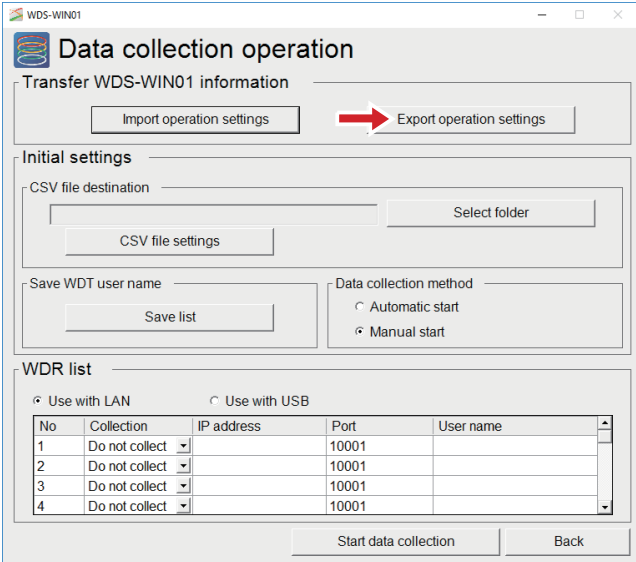
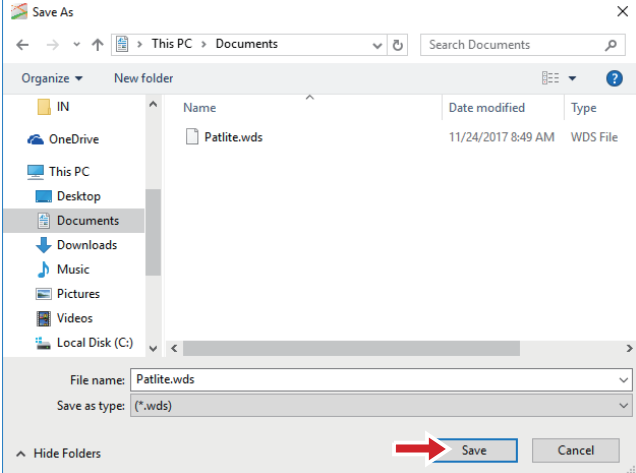
<p>1.</p> <ul style="list-style-type: none"> ■ Open [Data collection operation] screen. ■ Under [Transfer WDS-WIN01 information], click [Export operation settings]. 	 <p>The screenshot shows the 'Data collection operation' window with the following sections:</p> <ul style="list-style-type: none"> Transfer WDS-WIN01 information: Contains 'Import operation settings' and 'Export operation settings' buttons. A red arrow points to the 'Export operation settings' button. Initial settings: Includes 'CSV file destination' with a 'Select folder' button and 'CSV file settings'. Save WDT user name: Includes a 'Save list' button. Data collection method: Includes radio buttons for 'Automatic start' and 'Manual start' (which is selected). WDR list: Includes radio buttons for 'Use with LAN' (selected) and 'Use with USB'. Below is a table: <table border="1" style="width: 100%; border-collapse: collapse;"> <thead> <tr> <th>No</th> <th>Collection</th> <th>IP address</th> <th>Port</th> <th>User name</th> </tr> </thead> <tbody> <tr> <td>1</td> <td>Do not collect</td> <td></td> <td>10001</td> <td></td> </tr> <tr> <td>2</td> <td>Do not collect</td> <td></td> <td>10001</td> <td></td> </tr> <tr> <td>3</td> <td>Do not collect</td> <td></td> <td>10001</td> <td></td> </tr> <tr> <td>4</td> <td>Do not collect</td> <td></td> <td>10001</td> <td></td> </tr> </tbody> </table> 	No	Collection	IP address	Port	User name	1	Do not collect		10001		2	Do not collect		10001		3	Do not collect		10001		4	Do not collect		10001	
No	Collection	IP address	Port	User name																						
1	Do not collect		10001																							
2	Do not collect		10001																							
3	Do not collect		10001																							
4	Do not collect		10001																							
<p>2.</p> <ul style="list-style-type: none"> ■ The "Save As" screen appears. ■ Choose a file to save settings information. <p>Enter a file name and click [Save].</p>	 <p>The screenshot shows the 'Save As' dialog box with the following details:</p> <ul style="list-style-type: none"> Location: This PC > Documents File name: Patlite.wds Save as type: (*.wds) Buttons: 'Save' and 'Cancel'. A red arrow points to the 'Save' button. 																									
<p>3.</p> <ul style="list-style-type: none"> ■ Finish 	<p style="text-align: center;">—</p>																									

6.3.2 Importing settings information

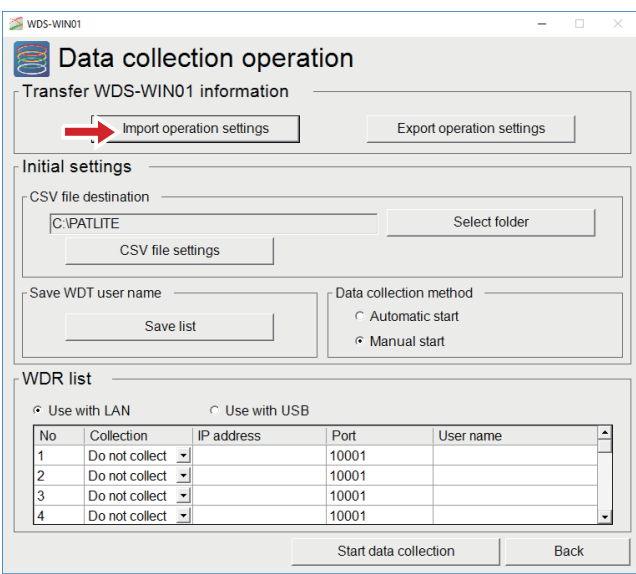
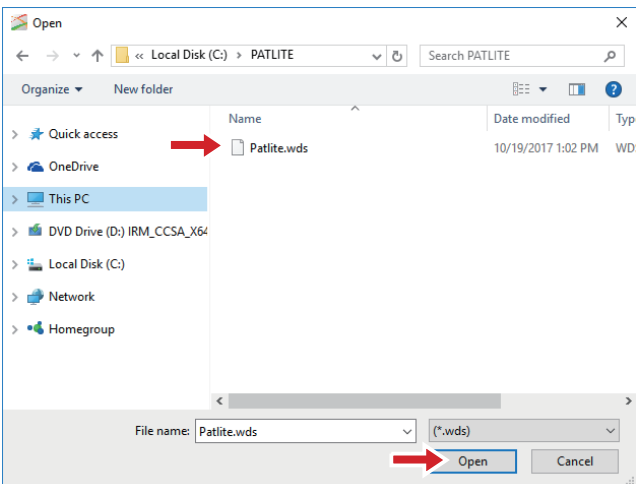
<p>1.</p> <ul style="list-style-type: none"> ■ Go to [Data collection operation] screen. ■ Under [Transfer WDS-WIN01 information], click [Import operation settings]. 	 <p>The screenshot shows the 'Data collection operation' window. The 'Transfer WDS-WIN01 information' section contains two buttons: 'Import operation settings' (highlighted with a red arrow) and 'Export operation settings'. Below this is the 'Initial settings' section with a 'CSV file destination' field set to 'C:\PATLITE', a 'Select folder' button, and a 'CSV file settings' button. There is also a 'Save WDT user name' section with a 'Save list' button. The 'Data collection method' section has radio buttons for 'Automatic start' and 'Manual start' (selected). The 'WDR list' section has radio buttons for 'Use with LAN' (selected) and 'Use with USB'. Below this is a table with columns: No, Collection, IP address, Port, and User name. The table contains four rows, all with 'Do not collect' in the Collection column and '10001' in the Port column.</p> <table border="1" data-bbox="821 660 1412 772"> <thead> <tr> <th>No</th> <th>Collection</th> <th>IP address</th> <th>Port</th> <th>User name</th> </tr> </thead> <tbody> <tr> <td>1</td> <td>Do not collect</td> <td></td> <td>10001</td> <td></td> </tr> <tr> <td>2</td> <td>Do not collect</td> <td></td> <td>10001</td> <td></td> </tr> <tr> <td>3</td> <td>Do not collect</td> <td></td> <td>10001</td> <td></td> </tr> <tr> <td>4</td> <td>Do not collect</td> <td></td> <td>10001</td> <td></td> </tr> </tbody> </table>	No	Collection	IP address	Port	User name	1	Do not collect		10001		2	Do not collect		10001		3	Do not collect		10001		4	Do not collect		10001	
No	Collection	IP address	Port	User name																						
1	Do not collect		10001																							
2	Do not collect		10001																							
3	Do not collect		10001																							
4	Do not collect		10001																							
<p>2.</p> <ul style="list-style-type: none"> ■ The [Open] window should appear, as shown to the right. <p>Select the settings information file (.wds) to import.</p> <ul style="list-style-type: none"> ■ Click the [Open] button. 	 <p>The screenshot shows a Windows 'Open' file dialog box. The address bar shows the path 'Local Disk (C:) > PATLITE'. The file list shows a single file named 'Patlite.wds' with a date modified of '10/19/2017 1:02 PM'. A red arrow points to the file. The 'File name' field at the bottom contains 'Patlite.wds' and the file type is set to '*.wds'. A red arrow points to the 'Open' button.</p>																									
<p>3.</p> <ul style="list-style-type: none"> ■ Finish 	<p>—</p>																									

6.4 Obtaining WDT user names for WDS-AUTO2

1.
 - Open the [Data collection operation] screen.
 - Under [Save WDT user name], click [Save list].

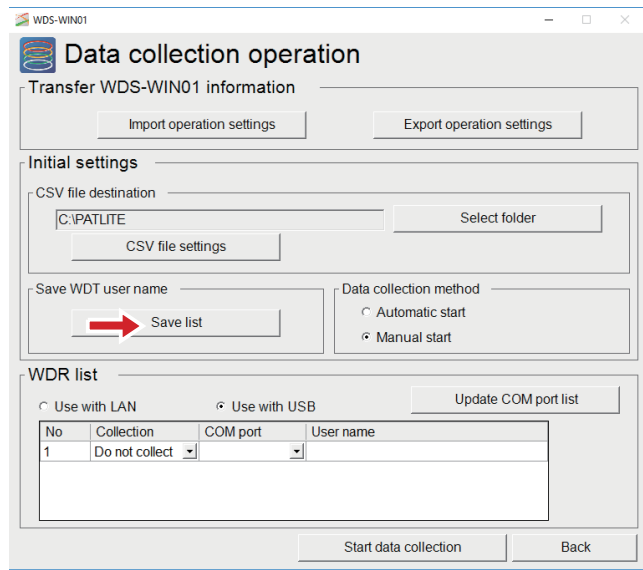

2.
 - The [Save WDT user name] screen should appear. Click the [Import (.init file)] button at the bottom of the screen.

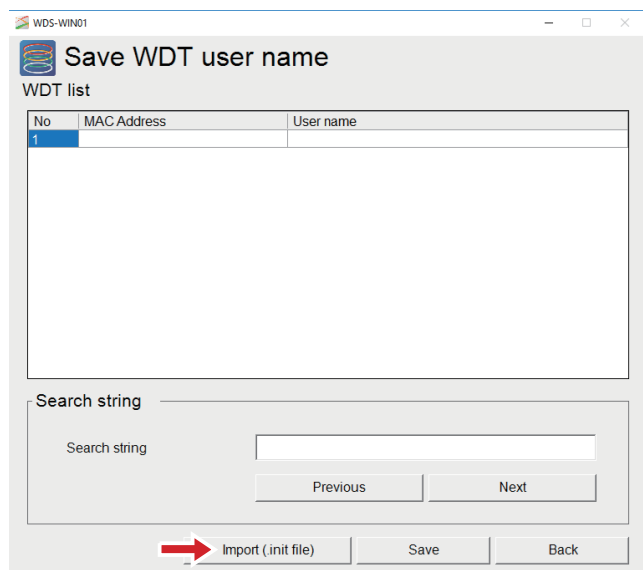

3.
 - The [Open] window should appear, as shown to the right. Select the WDT user name file (.init file) to import.
 - Click the [Open] button.

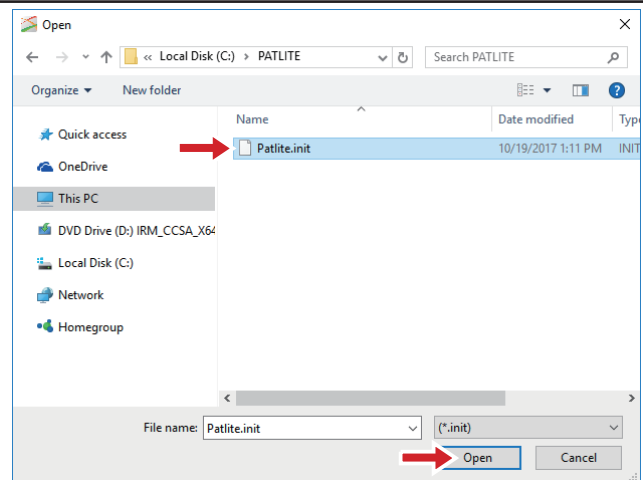

4.
 - Finish

 CAUTION



- ◆ If a user name is already registered, it will be imported again.
- ◆ If the number of user names registered reaches its maximum capacity, an error message will appear, and will not import any further.
- ◆ Import can not occur when there is a duplicated MAC address in the .init file.

6.5 Check WDT and WDR settings

(1) Check WDT settings

- Open up the [WDT/WDR settings] screen. (Refer to the following steps to open screen.)
 - For LAN, refer to steps 1 to 3 in section "6.1.2 (1)".
 - For USB, refer to steps 1 to 3 in section "6.1.2 (2)".

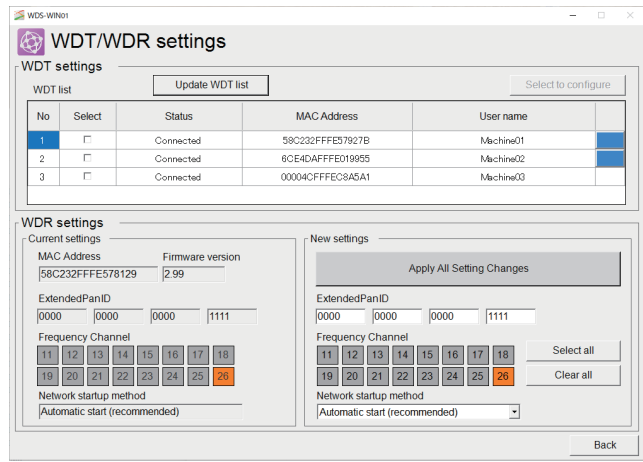

- The [WDT list] under [WDT settings] shows the WDT units that are currently connected.
 - * It may take about 10 seconds to display the WDT list.
 - Select the check boxes of WDT to set up, and click [Select to configure].

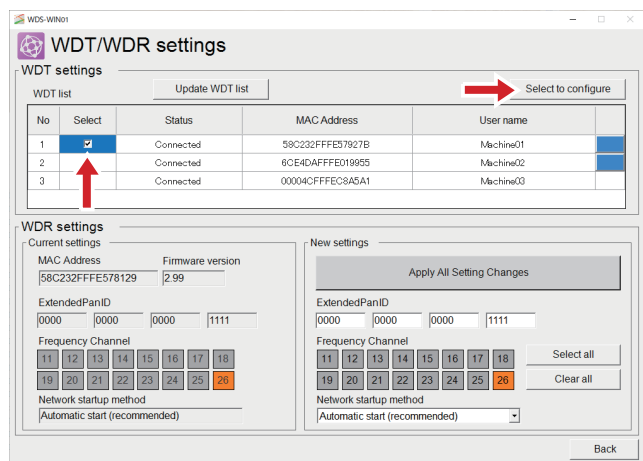

- [For WDT]**
 - The current settings of the selected WDT are displayed. Confirm the following fields:
 - [MAC address]
 - [ExtendedPanID]
 - [Frequency Channel]
 - [Determine Signal Tower Input]
 - [Power supply settings]
 - [Counter Settings]
 - [Transmission mode]

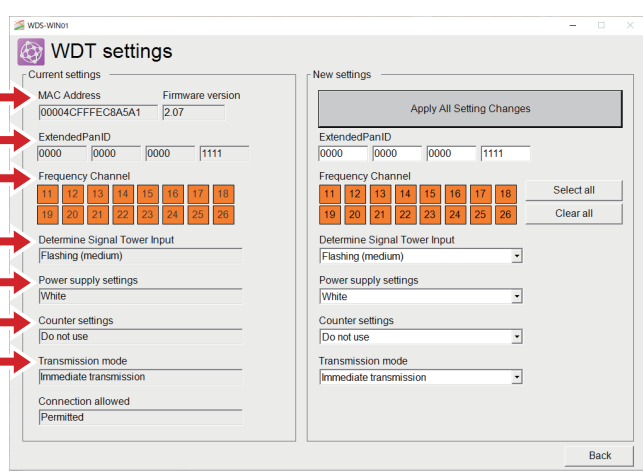

【For WDT-PRO】

- The current settings of the selected WDT are displayed. Confirm the following fields:
 - [ExtendedPanID]
 - [Frequency Channel]
 - [Determine Signal Tower Input]
 - [Power supply settings]
 - [Counter Settings]
 - [Transmission mode]
 - [Input Information Transmission Method]
 - [Signal Tower Format]
 - [Periodic Transmission]
 - [Sensitivity for Determining Simultaneous Input]
 - [File Format for Received Data]
 - [Baud Rate]
 - [Data Length]
 - [Parity]
 - [Stop Bit]

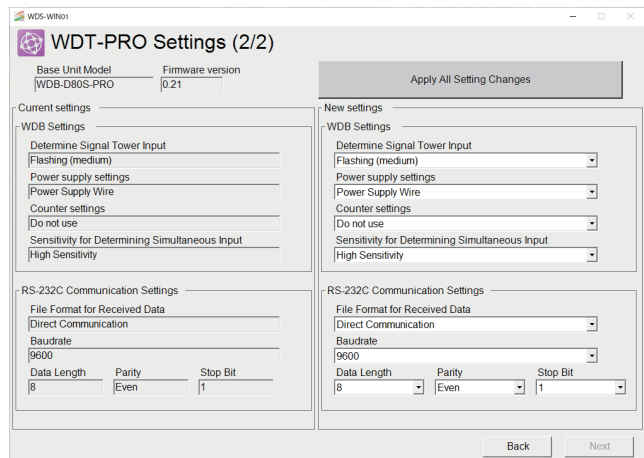
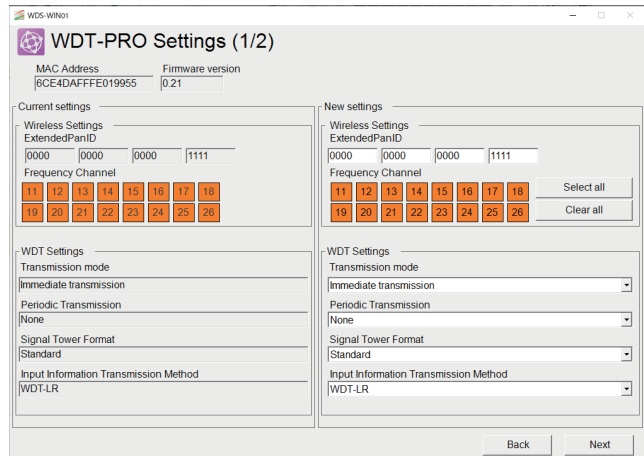

4. ■ Finish

(2) Check WDR settings

1. ■ Open up the [WDT/WDR settings] screen. (Refer to the following steps on how to open screen.)
 - For LAN, refer to steps 1 to 3 in section "6.1.2 (1)".
 - For USB, refer to steps 1 to 3 in section "6.1.2 (2)".

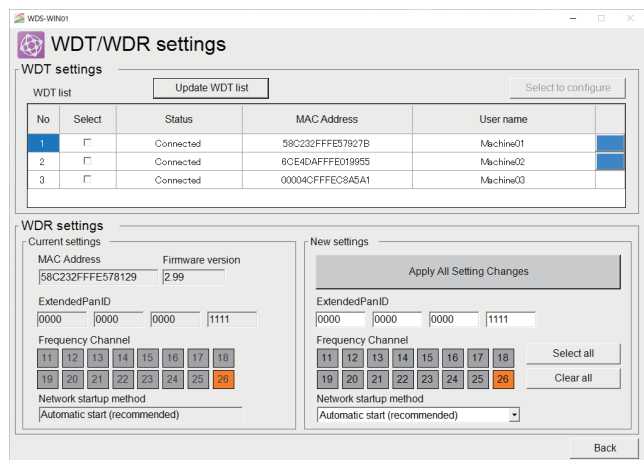

2. ■ The current settings of the WDR are displayed. Confirm the following fields:

- [MAC address]
- [ExtendedPanID]
- [Frequency Channel]
- [Network startup method]

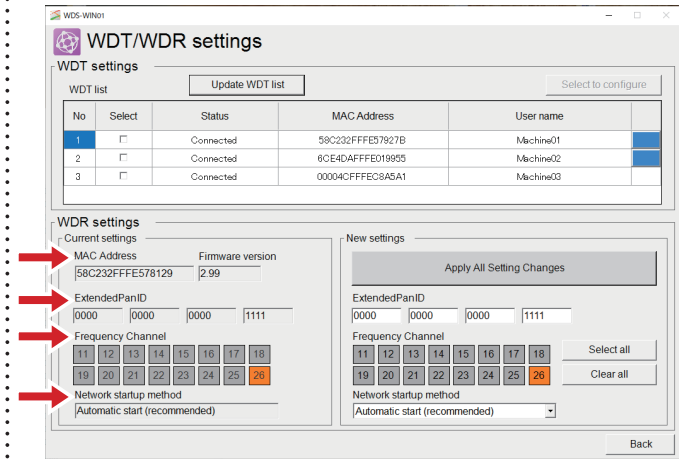

3. ■ Finish

6.6 Confirm WDT connection using WDT ping

Only for WDT-4LR/5LR/6LR-Z2 models and WDT-6LR-Z2-PRO

(1) Confirm from the [WDT/WDR settings] screen

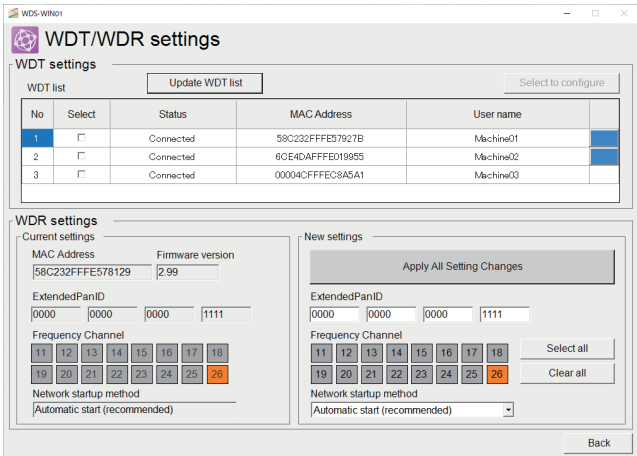
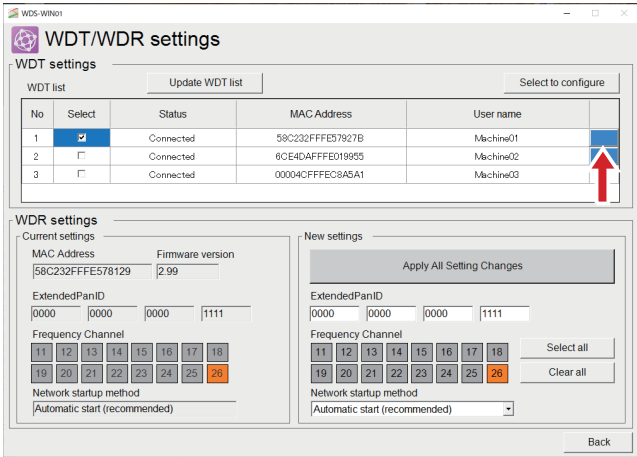
<p>1.</p> <ul style="list-style-type: none"> ■ Open up the [WDT/WDR settings] screen. (Refer to the following steps on how to open screen.) • For LAN, refer to steps 1 to 3 in section "6.1.2 (1)". • For USB, refer to steps 1 to 3 in section "6.1.2 (2)". * It may take about 10 seconds to display the WDT list. 	 <p>The screenshot shows the 'WDT/WDR settings' window. At the top, there's a 'WDT list' table with columns: No, Select, Status, MAC Address, and User name. Three units are listed, all with 'Connected' status. Below the table are 'WDR settings' and 'New settings' sections with various input fields and buttons like 'Apply All Setting Changes' and 'Back'.</p>
<p>2.</p> <ul style="list-style-type: none"> ■ Under the [WDT list], there should be a blue button on the right side of each connected WDT. (Not available for the WDT-5E/6M-Z2 models.) ■ When clicking a blue button, the indicator of the respective WDT flashes blue for about 10 seconds. This function can be used to locate a specific WDT unit. 	 <p>This screenshot is identical to the one above, but a red arrow points to a small blue button located on the right side of the first row in the 'WDT list' table.</p>
<p>3.</p> <ul style="list-style-type: none"> ■ Finish 	<p style="text-align: center;">—</p>

(2) Confirm from the [Collecting data -- WDR information --] screen

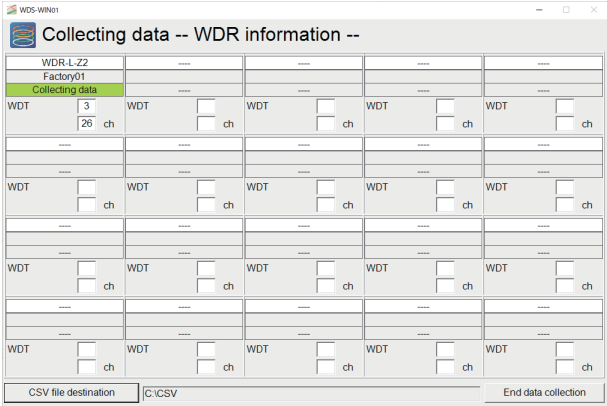
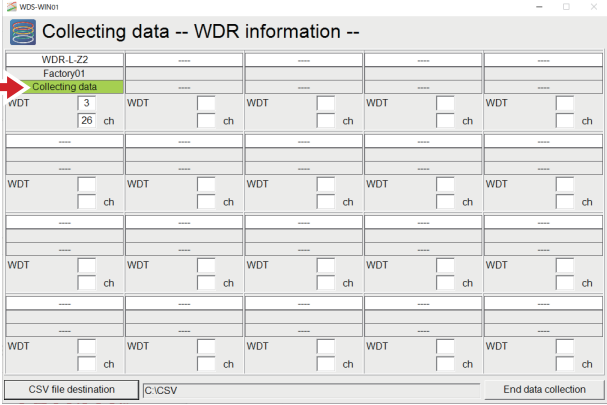
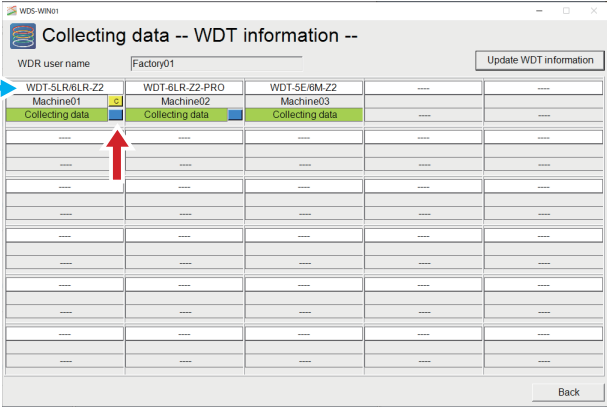
<p>1.</p> <ul style="list-style-type: none"> ■ Open up the [Collecting data -- WDR information --] screen. (Refer to the following steps on how to open screen.) • For LAN, refer to steps 1 to 5 in section "6.2.4 (1)". • For USB, refer to steps 1 to 5 in section "6.2.4 (2)". 	
<p>2.</p> <ul style="list-style-type: none"> ■ Click on the cell that displays the WDR status (indicated by arrow). This will open up the [Collecting data -- WDT information --] screen. 	
<p>3.</p> <ul style="list-style-type: none"> ■ There should be a blue button on the right side of each WDT status cell. <p>(Not available for the WDT-5E/6M-Z2 models.)</p> <ul style="list-style-type: none"> ■ When clicking a blue button, the indicator of the respective WDT flashes blue for about 10 seconds. This function can be used to locate a specific WDT unit. <p>* Even if the transmitter that is connected is WDT-4LR-Z2, "WDT-5LR/6LR-Z2" is displayed.</p>	
<p>4.</p> <ul style="list-style-type: none"> ■ Finish 	<p style="text-align: center;">—</p>

6.7 Clear Counter value

- Open up the [Collecting data -- WDR information --] screen. (Refer to the following steps on how to open screen.)

- For LAN, refer to steps 1 to 5 in section "6.2.4 (1)".
- For USB, refer to steps 1 to 5 in section "6.2.4 (2)".

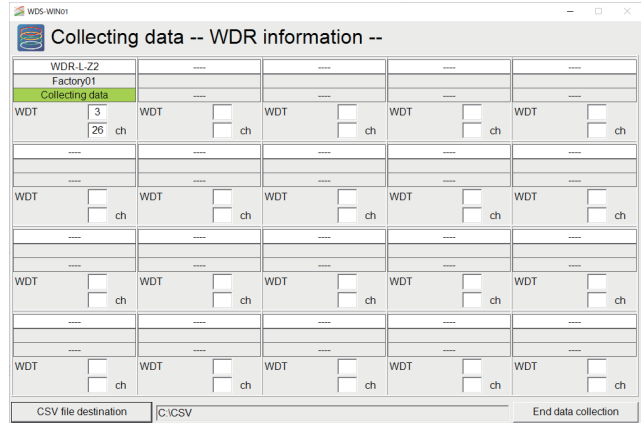

- Click on the WDR user name cell (indicated by arrow). This will open up the [Collecting data -- WDT information --] screen.

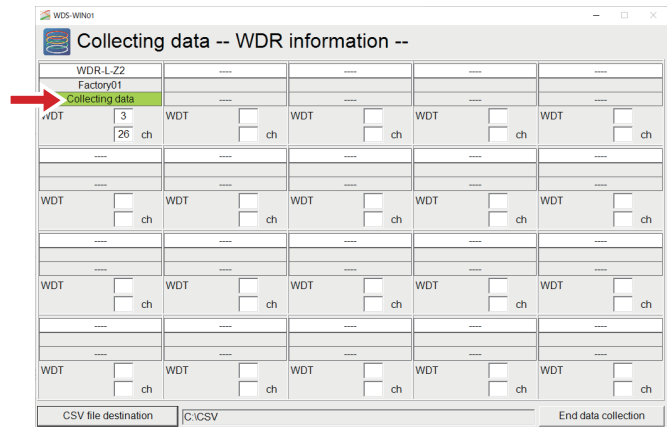

- There should be a yellow button with a 'c' on the right side of the user name cell.

* If you do not see a 'c' in the yellow button, refer to the [NOTICE] on the next page.

*1 Even if the transmitter that is connected is WDT-4LR-Z2, "WDT-5LR/6LR-Z2" is displayed.

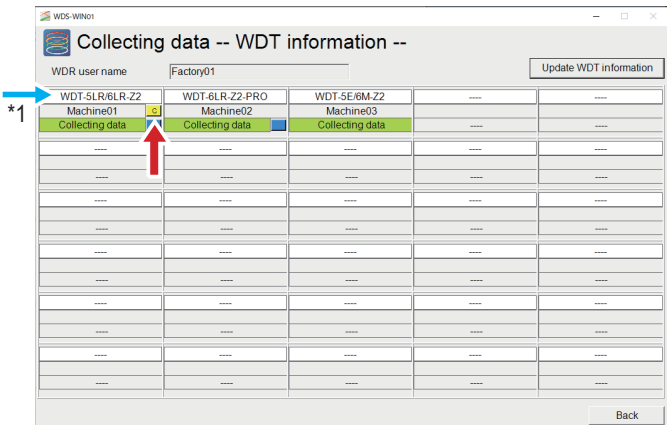

4. ■ Click on the yellow button with a 'c', and you should get a [Confirm Operation] pop-up.

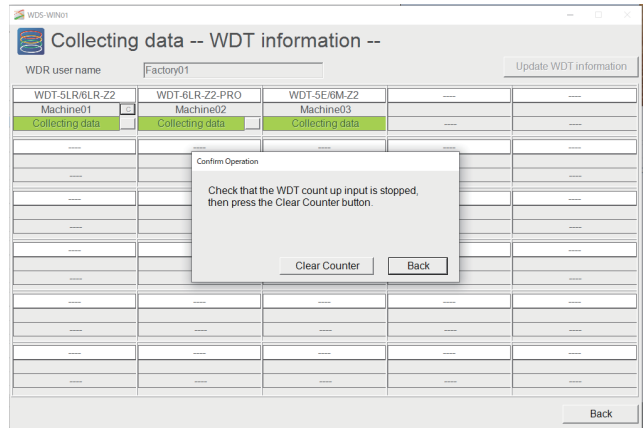

5. ■ Click on [Clear Counter], and you should get a pop-up indicating that the clear counter operation was successful.

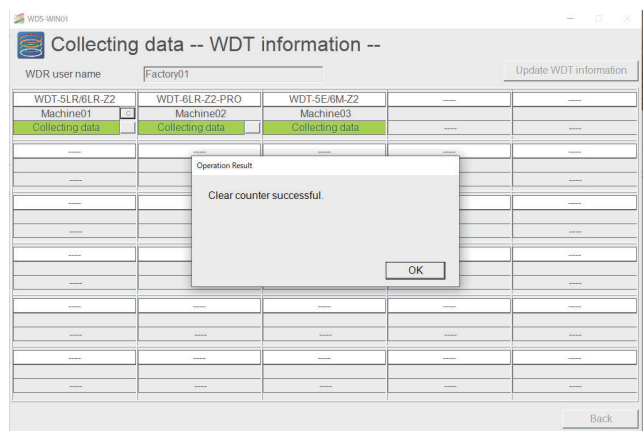

6. ■ Finish

NOTICE

- ◆ The following conditions may be why the 'c' does not display in the yellow button.
 - WDT-4LR-Z2/WDT-5LR-Z2/WDT-6LR-Z2 is version 3.06 or earlier.
 - In the [Counter Settings], the [Do not use] option is selected.

7 List of Settings

7.1 WDT/WDR settings

7.1.1 WDT settings

(1) List of Settings

■ WDT Series

Setup Item	Settings	References
Wireless settings	ExtendedPanID	☞ 7.1.1 (3) ①
	Frequency Channel	☞ 7.1.1 (3) ②
Run time settings	Determine Signal Tower Input	☞ 7.1.1 (3) ③
	Power supply settings	☞ 7.1.1 (3) ④
	Counter Settings	☞ 7.1.1 (3) ⑤
	Transmission mode	☞ 7.1.1 (3) ⑥

■ WDT-PRO Series

Setup Item	Settings	References
Wireless settings	ExtendedPanID	☞ 7.1.1 (3) ①
	Frequency Channel	☞ 7.1.1 (3) ②
Run time settings	Determine Signal Tower Input	☞ 7.1.1 (3) ③
	Power supply settings	☞ 7.1.1 (3) ④
	Counter Settings	☞ 7.1.1 (3) ⑤
	Transmission mode	☞ 7.1.1 (3) ⑥
	Periodic Transmission	☞ 7.1.1 (3) ⑦
	Signal Tower Format	☞ 7.1.1 (3) ⑧
	Input Information Transmission Method	☞ 7.1.1 (3) ⑨
	Sensitivity for Determining Simultaneous Input	☞ 7.1.1 (3) ⑩
RS-232C Communication Settings	File Format for Received Data	☞ 7.1.1 (3) ⑪
	Baud Rate	☞ 7.1.1 (3) ⑫
	Data Length	☞ 7.1.1 (3) ⑬
	Parity	☞ 7.1.1 (3) ⑭
	Stop Bit	☞ 7.1.1 (3) ⑮

(2) Layout of settings

■ WDT

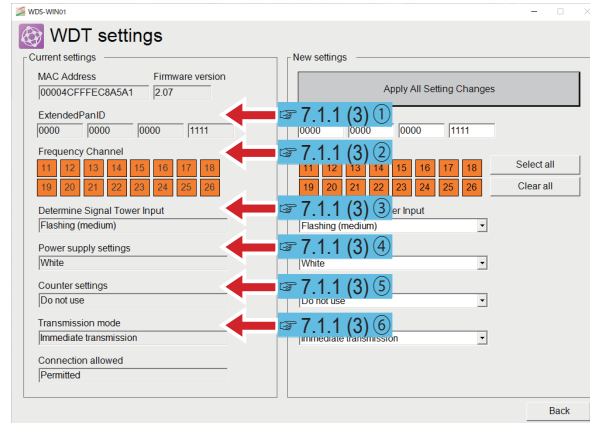

■ WDT-PRO

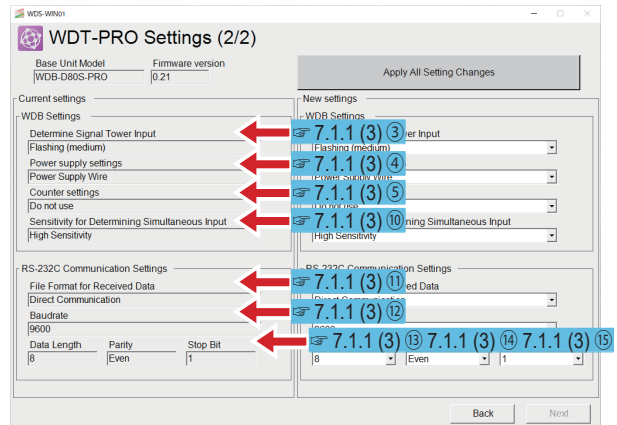
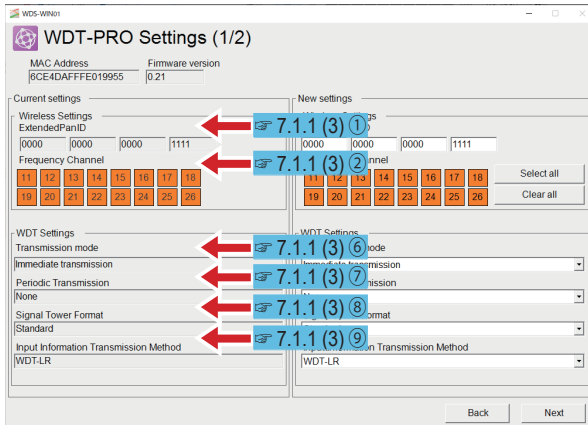

(3) Description of settings



① ExtendedPanID

Description
The ExtendedPanID is used to group a WDR with WDT units.
Setup process
Enter 16 single-byte alphanumeric characters
Setup value
0000 0000 0000 0000 to FFFF FFFF FFFF FFFE

 CAUTION	
	<ul style="list-style-type: none"> ◆ By default, the EPID of the WDT is 0000 0000 0000 0000, which is the value for universal search mode, and will usually link to the closest receiver grouping. To avoid interference of groupings, change the ExtendedPanID of the WDT during configuration.

② Frequency Channel

Description
Set the wireless frequency band for the WD system.
Setup process
Select check boxes (multiple selections possible)
Setup value
CH11 / CH12 / CH13 / CH14 / CH15 / CH16 / CH17 / CH18 / CH19 / CH20 / CH21 / CH22 / CH23 / CH24 / CH25 / CH26

 CAUTION	
	<ul style="list-style-type: none"> ◆ Select at least one channel. ◆ Make sure that the WDT and WDR have at least one common channel number.

③ Determine Signal Tower Input

Description
Define the input setting of the signal tower.
Setup process
Choose flash speed from drop-down menu
Setup value
<p>Choose Flash Speed:</p> <p>Normal = No flashing</p> <p>Flashing (short): SS seconds = 0.7 seconds</p> <p>Flashing (medium): SS seconds = 1.5 seconds</p> <p>Flashing (long): SS seconds = 2.5 seconds</p> <p>* Flashing is identified when there are two status changes within a defined period. This period is called "SS seconds".</p> <p>For more information, refer to  section 9.1.2 "Determine Signal Tower Input" in the "[WDT- □ LR-Z2/WDR-L(E)-Z2-PRO Instruction Manual]".</p>

④ Power supply settings

Description
Select the wire to use as a power supply.
Setup process
Selection list
Setup value
Power supply wire: Red, Yellow, Green, Blue, or White

NOTICE

- ◆ Depending on the WDT model, the wire(s) used as the power supply source will vary.
 - WDT-4LR-Z2/WDT-5LR-Z2/WDT-6LR-Z2: Select [Power supply wire].
 - WDT-5E-Z2/WDT-6M-Z2: Select a wire from [Red] to [White].

⑤ Counter Settings

Description
Select a signal wire to use for the Simple Counter Function.
Setup process
Selection list
Setup value
Select from: Do not use, Red, Amber, Green, Blue, White, Buzzer

NOTICE
<ul style="list-style-type: none"> ◆ The above settings are for WDT-4LR-Z2/WDT-5LR-Z2/WDT-6LR-Z2 (version 3.06 or later). The buzzer cannot be set for the counter function for WDT-5E-Z2/WDT-6M-Z2. ◆ For WDT-4LR-Z2, WDT-5LR-Z2, and WDT-6LR-Z2, DIP switch 2 can be turned ON to activate the counter function. In this case, the blue wire will be used. For more information, refer to  section 9.1.1 "Wireless Data Transmission Function" in the "[WDT-□ LR-Z2/WDR-L(E)-Z2-PRO(-L) Instruction Manual]". ◆ The counter value recorded by the WDT does not get cleared even after setting the Counter settings to [Do not use] from the WDT settings menu. To clear counter values, use one of the following methods, then go back to the WDT settings and set the Counter settings to [Do not use]. <ul style="list-style-type: none"> ① From the [Collecting data -- WDT information --] screen, click on the yellow 'c' button on the right side of the user name cell. ② Turn off the power supply of the WDT unit.

⑥ Transmission mode

Description
Select how signal tower information is transmitted.
Setup process
Selection list
Setup value
Immediate transmission or Request transmission

 CAUTION	
	◆ When collecting data with this product, set WDT [Transmission mode] field to [Immediate transmission].

⑦ Periodic Transmission

Description
Choose specific information to transmit periodically.
Setup process
Selection list
Setup value
None, Unit Information, Input Information/Signal Tower Information For more information, refer to  section "8.4.2 Data Transmission Function" in the "[WD PRO Series (WDB-D80S-PRO, WDT-6LR-Z2-PRO) Instruction Manual]".

⑧ Signal Tower Format

Description
Select a transmission format in [WDT-LR] method
Setup process
Selection list
Setup value
Standard or Extension

* This setting is disabled when [WDT-PRO] method is selected.

⑨ Input Information Transmission Method

Description
Select how information is transmitted to WDR.
Setup process
Selection list
Setup value
WDT-PRO method or WDT-LR method For more information, refer to  section "8.4.2 Data Transmission Function" in the "[WD PRO Series (WDB-D80S-PRO, WDT-6LR-Z2-PRO) Instruction Manual]".

⑩ Sensitivity for Determining Simultaneous Input

Description
Adjust level of sensitivity when multiple status changes are recorded at once.
Setup process
Selection list
Setup value
High, Medium, Low For more information, refer to  section "8.2.3 Determining Simultaneous Input for Signal Tower Circuit Board and External Input" in the "[WD PRO Series (WDB-D80S-PRO, WDT-6LR-Z2-PRO) Instruction Manual]".

⑪ File Format for Received Data

Description
Select the file format for RS-232C data.
Setup process
Selection list
Setup value
Direct Communication, Barcode Reader (Denso Wave) Communication, Barcode Reader (Generic) Communication For more information, refer to  section "8.3.2 Data Receiver Function" in the "[WD PRO Series (WDB-D80S-PRO, WDT-6LR-Z2-PRO) Instruction Manual]".

⑫ Baud Rate

Description
Select the baud rate for RS-232C data communication.
Setup process
Selection list
Setup value
4800, 9600, 19200, 38400, 57600, 115200 (bps)

⑬ Data Length

Description
Select the data length for RS-232C data communication.
Setup process
Selection list
Setup value
7, 8 (bits)

⑭ Parity

Description
Select the parity for RS-232C data communication.
Setup process
Selection list
Setup value
None, Even, Odd

⑮ Stop Bit

Description
Select the stop bit for RS-232C data communication.
Setup process
Selection list
Setup value
1, 2 (bit(s))

7.1.2 WDR settings (computer connection settings)

(1) List of Settings

Setup Item	Settings	References
LAN connection settings	IP address	☞ 7.1.2 (3) ①
	Subnet mask	☞ 7.1.2 (3) ②
	Default gateway	☞ 7.1.2 (3) ③
	Port number	☞ 7.1.2 (3) ④
USB connection settings	COM port	☞ 7.1.2 (3) ⑤

 CAUTION

◆ You need to log in from a Web browser to set up operations related to LAN connection settings.

(2) Layout of settings

- Computer connection settings (LAN connection)

■ WDR-L-Z2/ WDR-LE-Z2

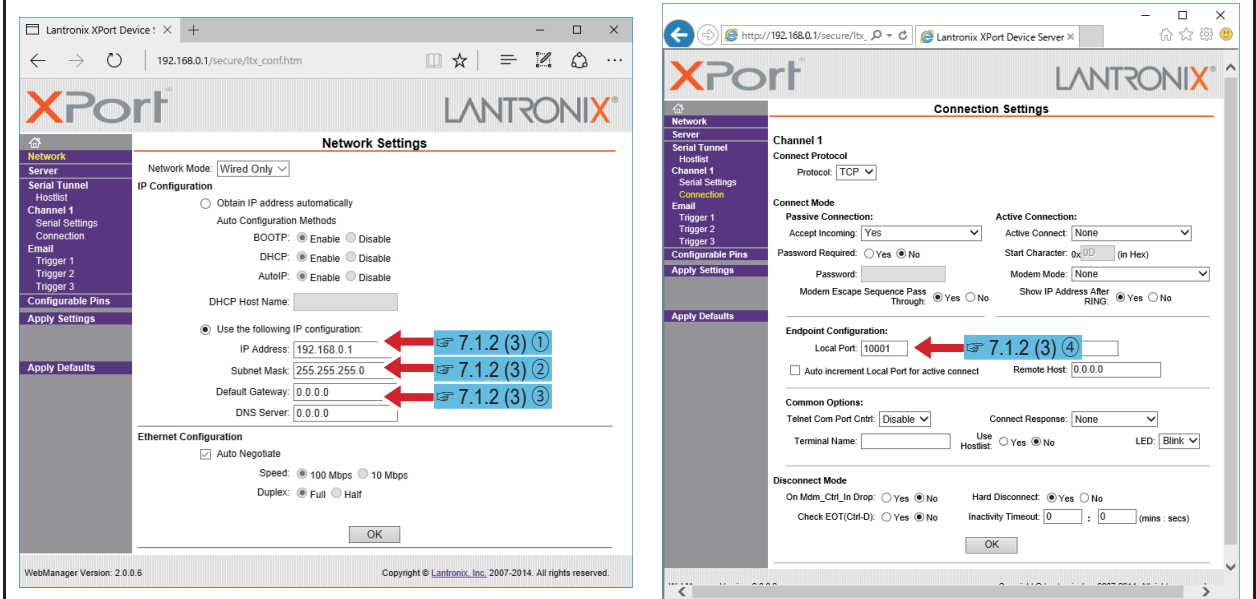

■ WD PRO Receiver

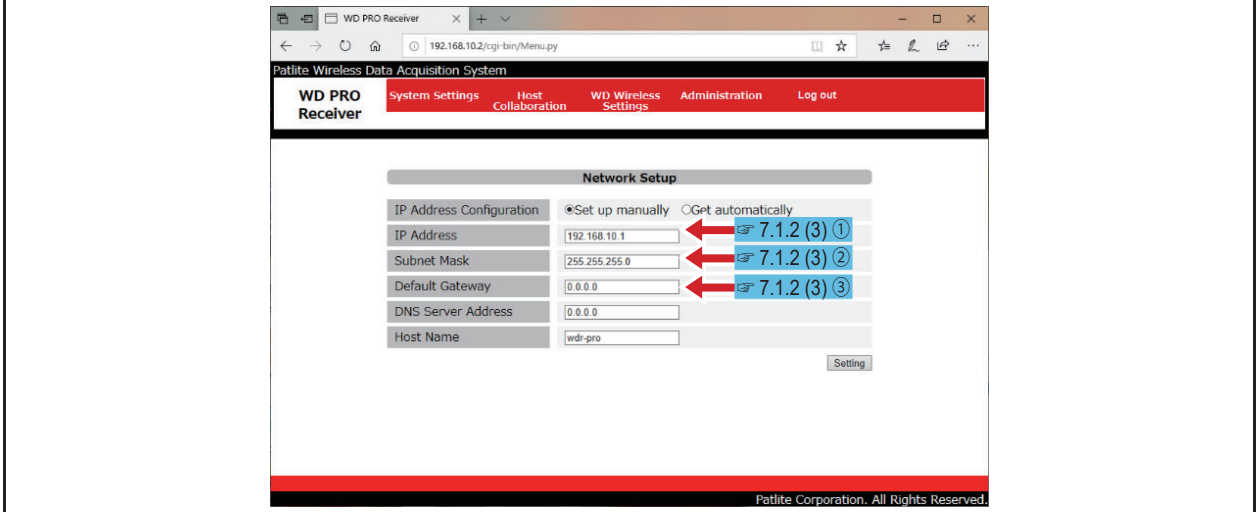

- Computer connection settings (USB connection)

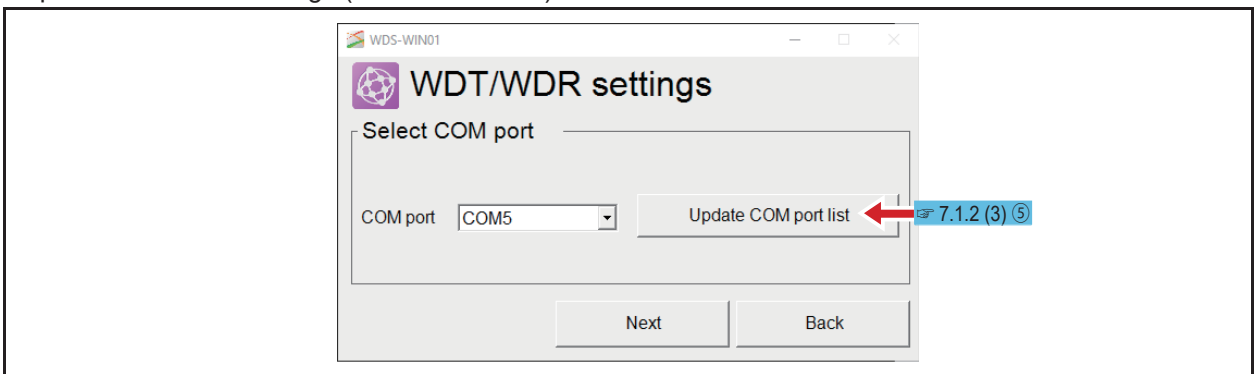

(3) Description of settings

 CAUTION	
	◆ Follow instructions from your system administrator to set up and select the correct values for settings. If incorrect values are set, the product will not operate correctly.

① IP address

Description
Enter the IP address of the WDR. (for use with LAN)
Setup process
Single-byte numeric characters (0 to 9) and periods (.)
Setup value
IPv4 IP address (xxx.xxx.xxx.xxx) where "xxx" is a value from 0 to 255

② Subnet mask

Description
Enter the subnet mask of the WDR.
Setup process
Single-byte numeric characters (0 to 9) and periods (.)
Setup value
IPv4 subnet mask (xxx.xxx.xxx.xxx) where "xxx" is a value from 0 to 255

③ Default gateway

Description
Enter the default gateway for the WDR.
Setup process
Single-byte numeric characters (0 to 9) and periods (.)
Setup value
Default gateway (xxx.xxx.xxx.xxx) where "xxx" is a value from 0 to 255

④ Port number

Description
Enter the port number of the WDR. (for use with LAN)
Setup process
Single-byte numeric characters (0 to 9)
Setup value
0 to 65535

⑤ COM port

Description
Select the COM port number. (for use with USB)
Setup process
Selection list
Setup value
COM port number displayed in the list

7.1.3 WDR settings (Wireless settings)

(1) List of Settings

Setup Item	Settings	References
Wireless settings	ExtendedPanID	☞ 7.1.3 (3) ①
	Frequency Channel	☞ 7.1.3 (3) ②
	Network startup method	☞ 7.1.3 (3) ③

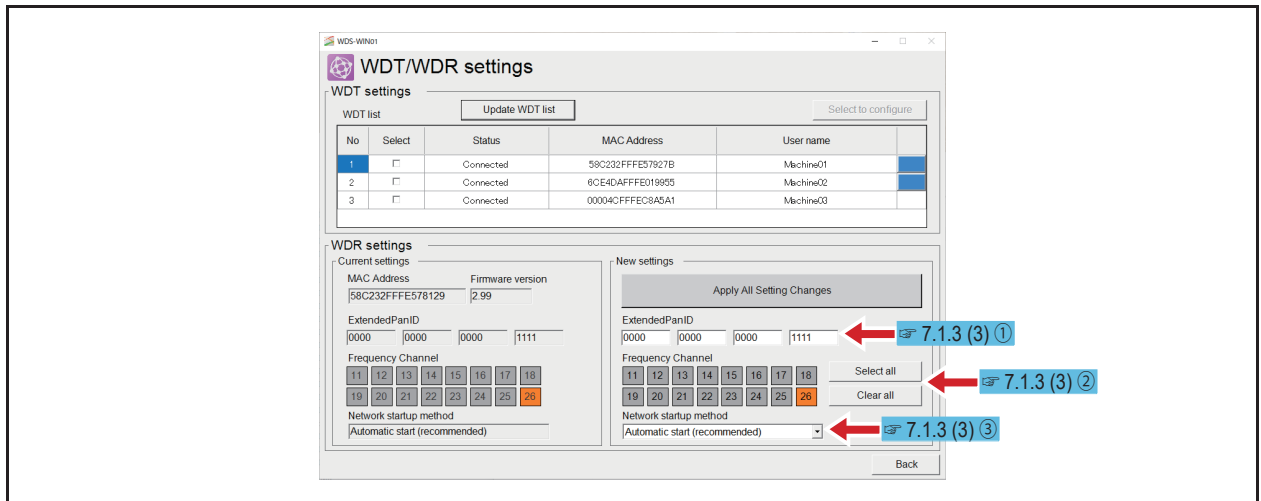

(2) Layout of settings



(3) Description of settings



① ExtendedPanID

Description
The ExtendedPanID is used to group a WDR with WDT units. For more information, refer to ☞ section "6.1.3 About Grouping and ExtendedPanID" in the "[WDT- □ LR-Z2/WDR-L(E)-Z2 Instruction Manual]".
Setup process
Enter single-byte alphanumeric characters (0 to 9 and A to F)
Setup value
0000 0000 0000 0000 to FFFF FFFF FFFF FFFE

 CAUTION	
	◆ When set to 0000 0000 0000 0000, it is treated as the same MACAddress as the WDR.



② Frequency Channel

Description
Select the wireless frequency band for the WD system. For more information, refer to  section "6.1.1 What is the WD Wireless Network?" in the "[WDT- □ LR-Z2/WDR-L(E)-Z2 Instruction Manual]".
Setup process
Select check boxes (multiple selections possible)
Setup value
CH11 / CH12 / CH13 / CH14 / CH15 / CH16 / CH17 / CH18 / CH19 / CH20 / CH21 / CH22 / CH23 / CH24 / CH25 / CH26

 CAUTION	
	<ul style="list-style-type: none"> ◆ Select at least one channel. ◆ Make sure that the WDT and WDR have at least one common channel number.

③ Network startup method

Description
Select how the network starts up when powering on the WDR.
Setup process
Selection list
Setup value
Automatic start (recommended) / Manual start

 CAUTION	
	<ul style="list-style-type: none"> ◆ When used with this WDS-WIN01 software, select [Automatic start (recommended)].

7.2 Data collection

7.2.1 Initial settings (save as CSV file)

(1) List of Settings

Settings	References
CSV file destination	☞ 7.2.1 (3) ①
File creation method	☞ 7.2.1 (3) ②
File division method	☞ 7.2.1 (3) ③
CSV file format	☞ 7.2.1 (3) ④
Correct the time	☞ 7.2.1 (3) ⑤
On dividing, output information	☞ 7.2.1 (3) ⑥

(2) Layout of settings

The figure shows two screenshots of the WDS-WIN01 software interface. The top screenshot is the 'Data collection operation' window, and the bottom screenshot is the 'CSV file settings' window. Red arrows with numbered callouts (1-6) point to specific settings in both windows.

Data collection operation window:

- ① Points to the 'Select folder' button in the 'CSV file destination' section.

CSV file settings window:

- ② Points to the 'Common' radio button under 'File creation method'.
- ③ Points to the 'Divide by time' radio button under 'File division method'.
- ④ Points to the 'Date/Time' dropdown in the 'CSV file format' section.
- ⑤ Points to the 'Correct the time' checkbox.
- ⑥ Points to the 'On dividing, output information' checkbox.

(3) Description of settings

① CSV file destination

Description
Choose a destination to save collected data (CSV files).
Setup process
Define folder selection
Setup value
Local drive folder



 CAUTION	
	◆ Network drives and external storage devices (such as SD cards) cannot be specified as a save destination.

② File creation method

Description
Select how the CSV files are created. * The file name is created according to the selected method. For information, refer to  section "8.2.1 CSV file format".
Setup process
Toggle selection
Setup value
Common / Common (file name)*1 / Per WDR / Per WDT

*1: Enter any file name for [Common (file name)].

File name	Setup process
	Enter single-byte alphanumeric characters (0 to 9 and A to Z) and double-byte characters
	Setup value
	1 to 20 characters
	Initial value
	(blank)

 CAUTION	
	◆ When choosing either [Per WDR] or [Per WDT] in File creation method, subfolders for each MAC address are automatically created in the CSV file destination folder.

③ File division method

Description
CSV files are split up as defined by the selected method. For information on file names of divided files, refer to  section "8.2.2 CSV file name".
Setup process
Toggle selection
Setup value
Divide by date / Divide by time*1 / Divide by file size*2 / Do not divide

*1: In [Divide by time] mode, the time span is set using the below properties.



Enable / Disable	Setup process		
	Select check boxes		
	Setup value		
	<input checked="" type="checkbox"/> (enabled) <input type="checkbox"/> (disabled)		
	Initial value 1	Initial value 2	Initial value 3
	<input type="checkbox"/>	<input type="checkbox"/>	<input type="checkbox"/>
Hours	Setup process		
	Enter single-byte numeric characters (0 to 9)		
	Setup value		
	0 to 23		
	Initial value 1	Initial value 2	Initial value 3
	00	09	18
Minutes	Setup process		
	Enter single-byte numeric characters (0 to 9)		
	Setup value		
	0 to 59		
	Initial value 1	Initial value 2	Initial value 3
	00	00	00

*2: In [Divide by file size] mode, you can divide files based on the file size.

Size (KB)	Setup process
	Enter single-byte numeric characters (0 to 9)
	Setup value
	100 to 1000
	Initial value
	1000

④ CSV file format

Description
Select the types of information to include in the CSV file. *select up to 14 fields (the first field is locked as [Date/Time]). * For an example file output, refer to  section "8.2.4 Example CSV file output".
Setup process
Selection list
Setup value
No settings / MAC address (WDT) / User name (WDT) / Red information / Amber information / Green information / Blue information / White information / Buzzer information / WDT monitoring information / Counter value / RS-232C data (Hexadecimal) / RS-232C data (ASCII code) / External input information (Binary) / External input information (Decimal) / External input information (Hexadecimal) / Clear input information

 CAUTION	
	<ul style="list-style-type: none"> ◆ Each file format can only be selected once. ◆ Fields within your list of selected fields cannot be left at [No settings].

⑤ Correct the time

Description
<p>Choose whether or not to correct the time when saving Date and Time information to CSV.</p> <ul style="list-style-type: none"> * Depending on your network environment, there could be a slight lag between the actual time that the signal tower changed statuses, and when that status change was recorded as CSV data. This [Correct the time] function can improve time accuracy. * For the WDT-4LR/WDT-5LR/6LR-Z2 models and WDT-PRO series, this function is disabled when [Signal Tower Format] is set to [Standard]. <p>For information, refer to  section 9.1.1.2 "Select Format of Signal Tower Information" in the "[WDT- □ LR-Z2/WDR-L(E)-Z2 Instruction Manual]".</p>
Setup process
Select check boxes
Setup value
<input checked="" type="checkbox"/> (Correct) · <input type="checkbox"/> (Do not correct)

⑥ On dividing, output information

Description
<p>When dividing a CSV file, depending on the divide CSV file condition, select whether or not to output Signal Tower information of all transmitters for files to close and files to generate.</p> <ul style="list-style-type: none"> * For more information, refer to  section "8.2.7 Signal Tower Information Output When Dividing Files".
Setup process
Select check boxes
Setup value
<input checked="" type="checkbox"/> (output) · <input type="checkbox"/> (do not output)

7.2.2 Initial settings (Save WDT user name)

(1) List of Settings

Setup Item	References
Enter MAC Address	☞ 7.2.2 (3) ①
Enter user name	☞ 7.2.2 (3) ②
Search user name	☞ 7.2.2 (3) ③

(2) Layout of settings

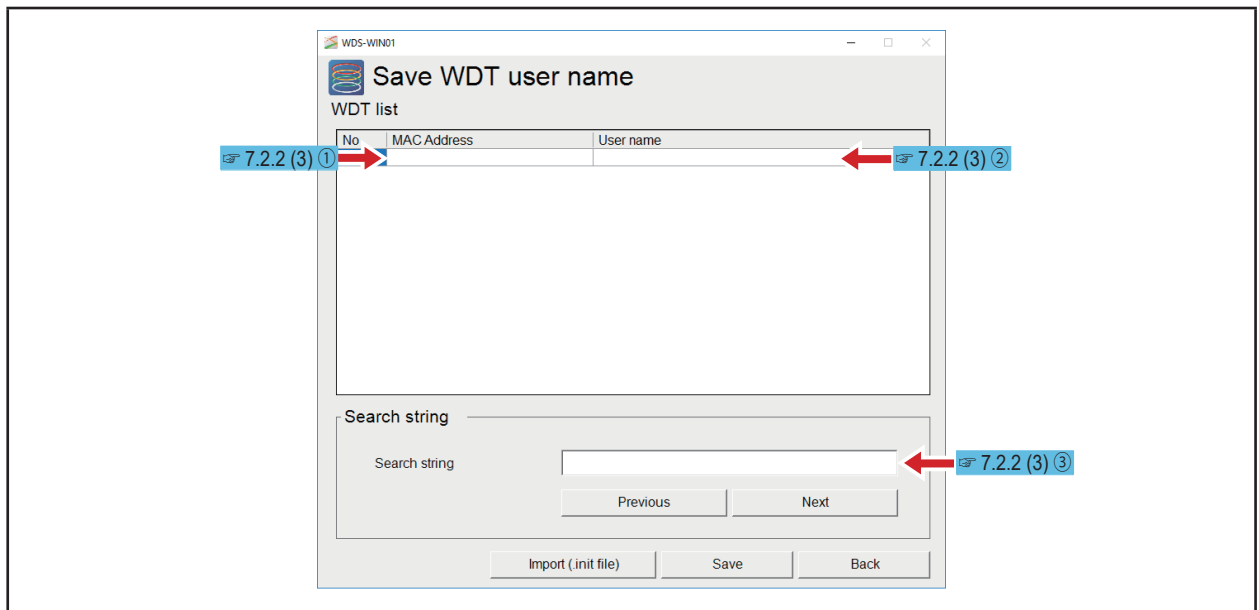

(3) Description of settings

① Enter MAC Address

Description
Register the MAC address.
Setup process
Enter single-byte alphanumeric characters (0 to 9 and A to F)
Setup value
16 single-byte alphanumeric characters

② Enter user name

Description
Register a user name with the MAC address.
Setup process
Enter single-byte alphanumeric characters, double-byte alphanumeric characters, hiragana, and kanji
Setup value
1 to 20 characters

③ Search user name

Description
Feature for searching registered user names.
Setup process
Enter single-byte alphanumeric characters, double-byte alphanumeric characters, hiragana, and kanji
Setup value
-

7.2.3 Initial settings (Data collection method)

(1) List of Settings

Setup Item	References
Data collection method	☞ 7.2.3 (3) ①

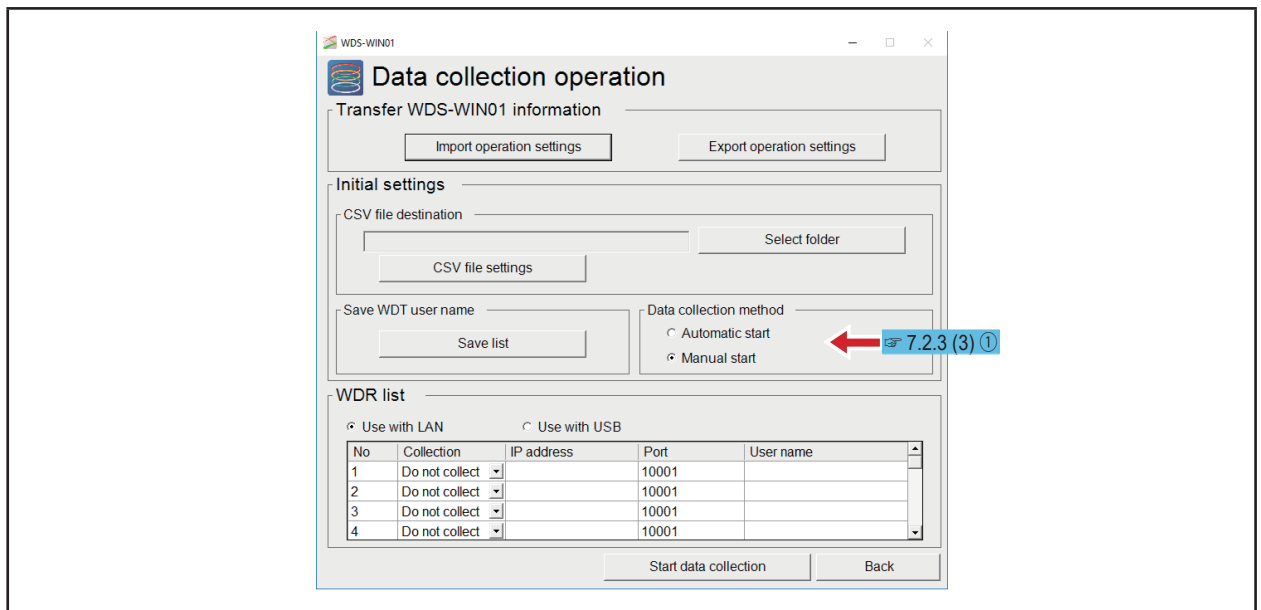

(2) Layout of settings



(3) Description of settings

① Data collection method

Description
Select how data collection is triggered when this product starts up. * When [Automatic start] is selected, data collection starts automatically from the next time this product starts up.
Setup process
Toggle selection
Setup value
Automatic start / Manual start

 CAUTION	
	◆ When [Automatic start] is selected, data collection starts automatically from the launch screen. To prevent starting automatically, select [Manual start].

7.2.4 Data collection

(1) List of Settings

Setup Item	References
Collection	☞ 7.2.4 (3) ①
User name	☞ 7.2.4 (3) ②

(2) Layout of settings

The screenshot shows the 'Data collection operation' window with the following details:

- Initial settings:** CSV file destination is 'C:\PATLITE'. Data collection method is 'Manual start'.
- WDR list:**

No	Collection	IP address	Port	User name
1	Do not collect		10001	
2	Do not collect		10001	
3	Do not collect		10001	
4	Do not collect		10001	

The second screenshot shows the 'Collecting data -- WDR information --' window with a grid of 'WDT' checkboxes and a 'CSV file destination' field set to 'C:\CSV'.

(3) Description of settings

① Collection

Description
Select the WDR to use for data collection. (LAN connection: maximum 20 units, USB connection: maximum 1 unit)
Setup process
Selection list
Setup value
Collect / Do not collect

② User name

Description
Register a user name for the WDR unit.
Setup process
Enter single-byte alphanumeric characters, double-byte alphanumeric characters, hiragana, and kanji
Setup value
1 to 20 characters

7.2.5 Transfer WDS-WIN01 information

(1) List of Settings

Setup Item	Setup Item	References
Import operation settings	None	—
Export operation settings	None	—

(2) Layout of settings

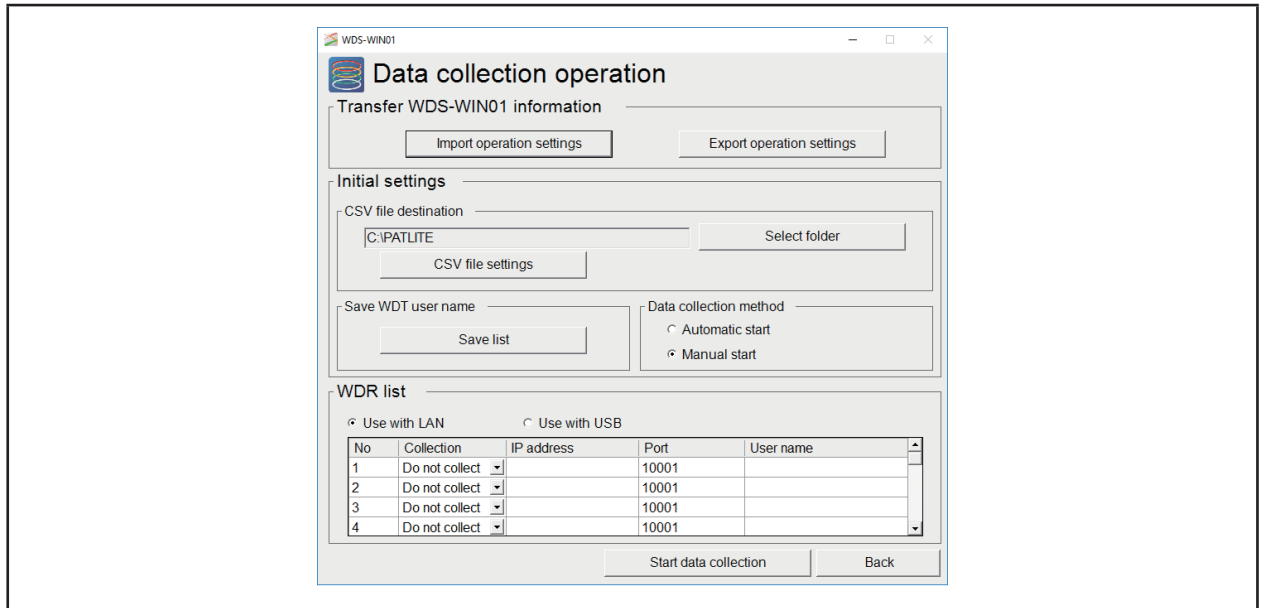

7.3 List of initial values

7.3.1 WDT/WDR settings

(1) WDT settings

■ WDT Series

Category	Setup Item	Initial value
Wireless settings	ExtendedPanID	0000 0000 0000 0000
	Frequency Channel	'CH11 - CH26' all ON
Run time settings	Determine Signal Tower Input	Flashing (medium)
	Power supply settings	Power line
	Counter Settings	Do not use
	Transmission mode	Immediate transmission

* These are the initial values for WDT-4LR-Z2/WDT-5LR-Z2/WDT-6LR-Z2.

NOTICE

- ◆ For WDT-5E-Z2 and WDT-6M-Z2, the default power supply is [White] wire.
- ◆ For WDT-4LR-Z2, WDT-5LR-Z2 and WDT-6LR-Z2, DIP switch 2 can be turned ON to activate the counter function. In this case, the [Blue] wire will be used.

■ WDT-PRO Series

Category	Setup Item	Initial value
Wireless settings	ExtendedPanID	0000 0000 0000 0000
	Frequency Channel	'CH11 - CH26' all ON
Run time settings	Determine Signal Tower Input	Flashing (medium)
	Power supply settings	Power line
	Counter Settings	Do not use
	Transmission mode	Immediate transmission
	Periodic Transmission	None
	Input Information Transmission Method	WDT-LR
	Signal Tower Format	Standard
	Sensitivity for Determining Simultaneous Input	High Sensitivity
RS-232C Communication Settings	File Format for Received Data	Direct Communication
	Baud Rate	9600
	Data Length	8
	Parity	None
	Stop Bit	1

* These are the initial values for WDT-6LR-Z2-PRO and WDB-D80S-PRO.

(2) WDR settings

■ For WDR-L-Z2/WDR-LE-Z2

Category	Setup Item	Initial value
Wireless settings	ExtendedPanID	0000 0000 0000 0000
	Frequency Channel	'CH11 - CH26' all ON
	Network startup method	Automatic start (recommended)
LAN communication	IP address	192.168.0.1
	Subnet mask	255.255.255.0
	Default gateway	0.0.0.0

■ For WD PRO receiver

Category	Setup Item	Initial value
Wireless settings	ExtendedPanID	0000 0000 0000 0000
	Frequency Channel	'CH11 - CH26' all ON
	Network startup method	Automatic start (recommended)
LAN communication	IP address	192.168.10.1
	Subnet mask	255.255.255.0
	Default gateway	0.0.0.0

7.3.2 Data collection

Category	Setup Item	Initial value
Initial settings	Data collection method	Manual start
	CSV file destination	(blank)
CSV file settings	File creation method	Common
	File division method	Divide by date
	When dividing, output Signal Tower information	<input type="checkbox"/> (do not output)
	CSV file format	1. Date/Time 2. MAC address (WDT) 3. User name (WDT) 4. Red information 5. Amber information 6. Green information 7. Blue information 8. White information 9. Buzzer information 10. WDT monitoring information 11. No settings 12. No settings 13. No settings 14. No settings
	Correct the time	<input type="checkbox"/> (unselected)
Save WDT user name	WDT user name	(undefined)
WDR list	WDR	Use with LAN
	IP address	(blank)
	Port	10001
	COM port	(blank)
	Collection	Do not collect
	WDR user name	(blank)

8 Specifications

8.1 Software specifications

Model		WDS-WIN01
Product name		Hardware System Setting Software
Supported products		WDR: WDR-L-Z2, WDR-LE-Z2 WDR-L-Z2-PRO, WDR-L-Z2-PRO-L, WDR-LE-Z2-PRO, WDR-LE-Z2-PRO-L WDT: WDT-6M-Z2, WDT-5E-Z2, WDT-4LR-Z2, WDT-5LR-Z2, WDT-6LR-Z2 WDT-6LR-Z2-PRO WDB: WDB-D80S-PRO
Maximum number of WDR connections		20 units (maximum 1 unit for USB serial connection)
WDR connection method		LAN socket connection / USB serial connection
Maximum number of WDT units to administer		600 units
Operation Environment	Supported operating systems	Windows® 7 (32/64-bit), Windows® 8.1 (32/64-bit), Windows® 10 (32/64-bit), Windows® 11 (64-bit), Windows® Server 2012 R2 (64-bit), Windows® Server 2016 (64-bit), Windows® Server 2019 (64-bit), Windows® Server 2022(64-bit)
	Supported languages	Japanese, English, Simplified Chinese, Traditional Chinese, Korean, Thai, Indonesian, Spanish (Select manually)
	Execution authority	Administrator / Standard user*1
	Requirements	Personal computer with standard Windows® operation (does not work with tablet PC). .NET Framework 4.5 installed
Standard functions		<input type="radio"/> Data collection*2 <ul style="list-style-type: none"> • Collect changes in input status information (Signal Tower / external input), RS-232C data and clear input information. • Output changes in input status information (Signal Tower / external input) to CSV data. • Output RC-232C data to CSV files. • Output Clear Input information to CSV files. • Output Counter Value Information to CSV files. <input type="radio"/> WDT/WDR settings <ul style="list-style-type: none"> • Set up and change WDT (including WDB) • Set up and change WDR

*1 When installing this product, the user must be logged in with administrator user rights.

*2 License authentication required to use this function

8.2 CSV file specifications

General description of the generated CSV files.

8.2.1 CSV file format

Format	CSV (Comma-Separated Values) file
Extension	csv
Character code	Unicode (UTF-8)
Linebreak code	CR+LF
Display language	Language defined in the [Language settings]

8.2.2 CSV file name

(1) File creation method: Common

File division method	File name		
	Static		Number
Divide by date	patlog	_auto	yyyy_mm_dd
Divide by time			
Divide by file size			
Do not divide			
			_nnnn

_nnnn: 0001 to 9999

(2) File creation method: Common (file name)

File division method	File name		
	Static	Characters	Number
Divide by date	patlog	Any characters	_nnnn
Divide by time			
Divide by file size			
Do not divide			

_nnnn: 0001 to 9999

(3) File creation method: Per WDR

File division method	File name				
	Static		Date	WDR MAC address	Number
Divide by date	patlog	_auto	yyyy_mm_dd	_Rxxxxxxxxxxxxxxxxxx	/
Divide by time					_nnnn
Divide by file size					
Do not divide					

_nnnn: 0001 to 9999

Folders are created automatically for each WDR and CSV files are saved in those folders.

Folder name
WDR MAC address
Rxxxxxxxxxxxxxxxxxx

(4) File creation method: Per WDT

File division method	File name				
	Static		Date	WDT MAC address	Number
Divide by date	patlog	_auto	yyyy_mm_dd	_Txxxxxxxxxxxxxxxxxx	/
Divide by time					_nnnn
Divide by file size					
Do not divide					





_nnnn: 0001 to 9999

Folders are created automatically for each WDT and CSV files are saved in those folders.

Folder name
WDT MAC address
Txxxxxxxxxxxxxxxxxx

8.2.3 Define information in CSV file output

(1) Description of CSV file format

CSV file format		Description	
Date/Time		yyyy/mm/ddhh:mm:ss	
MAC address		WDT MAC address information	
User name		WDT user name information (MAC address when user name not created)	
Signal Tower information	Red information	For output information, refer to  section "8.2.3 (2) Output information for signal tower, buzzer, WDT monitoring, and counter value"	
	Amber information		
	Green information		
	Blue information		
	White information		
Buzzer information			
WDT monitoring information			
Counter value			
External Input Information	Binary		For output information, refer to  section "8.2.3 (3) Outputs of external input information"
	Decimal		
	Hexadecimal		
RS-232C Data	ASCII character	For output information, refer to  section "8.2.3 (4) Outputs of RS-232C data"	
	Hexadecimal		
Clear Input Information		For output information, refer to  section "8.2.3 (5) Outputs for [clear input] information"	

(2) Output information for signal tower, buzzer, WDT monitoring, and counter value

Format	Output information	Description
Signal Tower information	0	Indicates signal tower information "light off".
	1	Indicates signal tower information "light on".
	2	Indicates signal tower information "flashing".
	9	Indicates signal tower information is defined as "power supply wire".
Buzzer information	0	Indicates buzzer information "off".
	1	Indicates buzzer information "on".
WDT monitoring information	0	Indicates "WDT not connected".
	9	Indicates "WDT connected".
Counter value	0 to 4,294,967,295	The total count (counter value) of pulse inputs measured by a designated signal wire.

(3) Outputs of external input information

Format		Output information	Description																																												
External Input Information	Binary	0000000 to 11111111	<p>The following describes the states of the 8 external inputs:</p> <table border="1"> <thead> <tr> <th></th> <th colspan="8">External input</th> </tr> <tr> <th></th> <th>8</th> <th>7</th> <th>6</th> <th>5</th> <th>4</th> <th>3</th> <th>2</th> <th>1</th> </tr> </thead> <tbody> <tr> <td>Byte</td> <td colspan="8">1</td> </tr> <tr> <td rowspan="2">Bit</td> <td>7</td> <td>6</td> <td>5</td> <td>4</td> <td>3</td> <td>2</td> <td>1</td> <td>0</td> </tr> <tr> <td colspan="4">MSB</td> <td colspan="4">LSB</td> </tr> </tbody> </table> <p>When external input is ON, the bit is 1; when external input is OFF, the bit is 0.</p> <p>Example) When external inputs 8 and 4 are ON and all the other inputs are OFF, the value is 10001000 (binary), 136 (decimal), or 88 (hexadecimal).</p>		External input									8	7	6	5	4	3	2	1	Byte	1								Bit	7	6	5	4	3	2	1	0	MSB				LSB			
		External input																																													
		8		7	6	5	4	3	2	1																																					
Byte	1																																														
Bit	7	6	5	4	3	2	1	0																																							
	MSB				LSB																																										
Decimal	0 to 255																																														
Hexadecimal	00 to FF																																														

(4) Outputs of RS-232C data

Format		Output information	Description
RS-232C Data	ASCII character	1 to 60 characters	Data input to RS-232C port.
	Hexadecimal	1 to 60 bytes	

(5) Outputs for [clear input] information

Format	Output information	Description
Clear Input Information	0	Clear input information is not performed.
	1	Clear input information was performed.

8.2.4 Example CSV file output

(1) Excel

- Signal tower, buzzer, WDT monitoring, and counter value

	A	B	C	D	E	F	G	H	I	J	K
#	Date/Time	MAC Address	User name	Red information	Amber information	Green information	Blue information	White information	Buzzer information	WDT monitoring information	Counter value
2	2019/1/17 13:58:20	xxxxxxxxxxxx01	Machine1	1	0	0	0	0	0	0	9
3	2019/1/17 13:58:54	xxxxxxxxxxxx01	Machine1	0	0	0	0	0	0	0	9
4	2019/1/17 19:04:09	xxxxxxxxxxxx01	Machine1	2	0	1	0	0	0	0	9
5	2019/1/17 19:05:30	xxxxxxxxxxxx01	Machine1	0	2	1	0	0	0	0	9

- External input information (hexadecimal), RS-232C data (ASCII character), clear input information

	A	B	C	D	E	F
#	Date/Time	MAC Address	User name	RS-232C Data(ASCII)	External Input Information(Hexadecimal)	Clear Input Information
2	2019/1/17 13:58:20	xxxxxxxxxxxx01	Machine1		0	0
3	2019/1/17 13:58:54	xxxxxxxxxxxx01	Machine1	2019TESTDATA	0	0
4	2019/1/17 14:06:01	xxxxxxxxxxxx01	Machine1		8	0
5	2019/1/17 14:22:01	xxxxxxxxxxxx01	Machine1		8	1

(2) Text

- Signal tower, buzzer, WDT monitoring, and counter value

```
Date/Time,MAC Address,User name,Red information,Amber information,Green information,Blue information,White information,Buzzer information,WDT monitoring information,Counter value
2019/1/17 13:58:20,xxxxxxxxxxxx01,Machine1,1,0,0,0,0,0,0,0
2019/1/17 13:58:54,xxxxxxxxxxxx01,Machine1,0,0,0,0,0,0,0,0
2019/1/17 19:04:09,xxxxxxxxxxxx01,Machine1,2,0,1,0,0,0,0,0,16
2019/1/17 19:05:30,xxxxxxxxxxxx01,Machine1,0,2,1,0,0,0,0,0,30
```

- External input information (hexadecimal), RS-232C data (ASCII character), clear input information



```
Date/Time,MAC Address,User name,RS-232C Data(ASCII),External Input Information(Hexadecimal),Clear Input Information
2019/1/17 13:58:20,xxxxxxxxxxxx01,Machine1,,00,0
2019/1/17 13:58:54,xxxxxxxxxxxx01,Machine1,"2019TESTDATA",00,0
2019/1/17 14:06:01,xxxxxxxxxxxx01,Machine1,,08,0
2019/1/17 14:22:01,xxxxxxxxxxxx01,Machine1,,08,1
```

CAUTION	
	<ul style="list-style-type: none"> ◆ The Date/Time information in the CSV file is obtained from the date and time set on the computer used to run this product. ◆ The CSV files for [counter value] are updated once per minute (may fluctuate depending on network status), and will not update every time there is a status change on the signal tower. ◆ For RS-232C data (ASCII character), control codes (0x00 - 0x1F, 0x7F) are replaced with spaces (0x20). ◆ For RS-232C data (ASCII character), data is enclosed in " " (double quotations). ◆ RS-232C data column will be blank if there is no output data.

8.2.5 About creating and dividing CSV files

When are files created?	When clicking [Start data collection].
	When the WDT recognizes a change in signal tower status.
When are files divided?	When conditions for file division is met, and the WDT recognizes a change in signal tower status.

For information on file names when creating and dividing files, refer to  section 「8.2.2 CSV file name」.

 CAUTION	
	<ul style="list-style-type: none"> ◆ Even when conditions for file division are met, if the WDT does not recognize a change in signal tower status, a new CSV file will not be created. ◆ When files are split, the last line of signal tower information from the previous file is recorded at the beginning of the new file. ◆ While collecting data, do not open or delete the CSV file. Either make a copy of the file for use, or wait until data collection is complete.

8.2.6 Example of CSV file division

The following are examples of how files are named when divided.

(1) File creation method: Common

File division method	File creation method	File name example
Divide by date	The dates in the file name change	patlog_auto2017_01_01.csv patlog_auto2017_01_02.csv
Divide by time	When the date is the same, only the serial number changes	patlog_auto2017_01_01_0001.csv patlog_auto2017_01_01_0002.csv
	When there is also a change in date, only the date changes	patlog_auto2017_01_01_0001.csv patlog_auto2017_01_02_0001.csv
Divide by file size	When the date is the same, only the serial number changes	patlog_auto2017_01_01_0001.csv patlog_auto2017_01_01_0002.csv
	When there is also a change in date, only the date changes	patlog_auto2017_01_01_0001.csv patlog_auto2017_01_02_0001.csv
Do not divide	File is not divided	patlog_auto2017_01_01.csv

(2) File creation method: Common (file name)

File division method	File creation method	File name example
Divide by date	Only the serial number changes	patlogOptionalName_0001.csv patlogOptionalName_0002.csv
Divide by time		
Divide by file size		
Do not divide	File is not divided	patlogOptionalName.csv

(3) File creation method: Per WDR

File division method	File creation method	File name example
Divide by date	The dates in the file name date change	patlog_auto2017_01_01_R0000000000000001.csv patlog_auto2017_01_02_R0000000000000001.csv
Divide by time	When the date is the same, only the serial number changes	patlog_auto2017_01_01_R0000000000000001_0001.csv patlog_auto2017_01_01_R0000000000000001_0002.csv
	When there is also a change in date, only the date changes	patlog_auto2017_01_01_R0000000000000001_0001.csv patlog_auto2017_01_02_R0000000000000001_0001.csv
Divide by file size	When the date is the same, only the serial number changes	patlog_auto2017_01_01_R0000000000000001_0001.csv patlog_auto2017_01_01_R0000000000000001_0002.csv
	When there is also a change in date, only the date changes	patlog_auto2017_01_01_R0000000000000001_0001.csv patlog_auto2017_01_02_R0000000000000001_0001.csv
Do not divide	File is not divided	patlog_auto2017_01_01_R0000000000000001.csv

(4) File creation method: Per WDT

File division method	File creation method	File name example
Divide by date	The dates in the file name date change	patlog_auto2017_01_01_T0000000000000001.csv patlog_auto2017_01_02_T0000000000000001.csv
Divide by time	When the date is the same, only the serial number changes	patlog_auto2017_01_01_T0000000000000001_0001.csv patlog_auto2017_01_01_T0000000000000001_0002.csv
	When there is also a change in date, only the date changes	patlog_auto2017_01_01_T0000000000000001_0001.csv patlog_auto2017_01_02_T0000000000000001_0001.csv
Divide by file size	When the date is the same, only the serial number changes	patlog_auto2017_01_01_T0000000000000001_0001.csv patlog_auto2017_01_01_T0000000000000001_0002.csv
	When there is also a change in date, only the date changes	patlog_auto2017_01_01_T0000000000000001_0001.csv patlog_auto2017_01_02_T0000000000000001_0001.csv
Do not divide	File is not divided	patlog_auto2017_01_01_T0000000000000001.csv

8.2.7 Signal Tower Information Output When Dividing Files

The following is an example when the [On dividing, output information] property is set to (output).

- When dividing files, at the end of the file to close and in the header of the file that is generated, the Signal Tower information of all WDT is added. This information includes all WDT (including no changes and not connected) that have been connected from the beginning to the end of data collection.

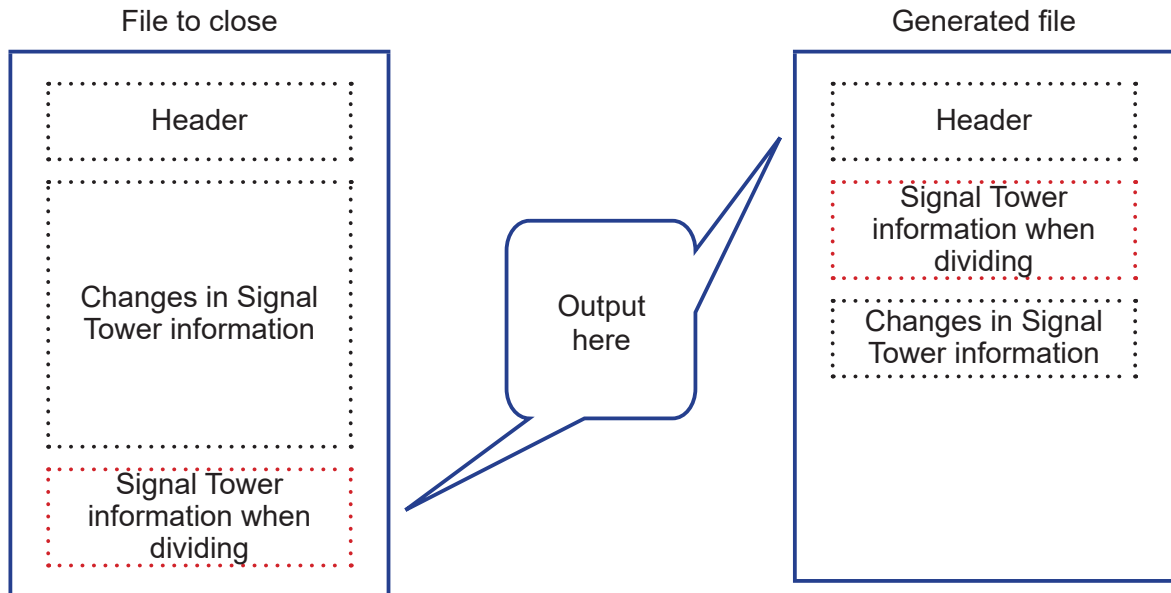

CAUTION



- ◆ The Signal Tower information when dividing files may include WDT Signal Tower information with different dates and times as it includes information that has not changed and information of WDT that are no longer connected.

9 Troubleshooting

9.1 Troubleshooting

If you have any questions about this product, please contact your nearest PATLITE Sales Representative.

Number	Issue	Checklist																		
01	Unable to install.	<ul style="list-style-type: none"> When installing this product, be sure that you are logged in with administrator rights. If you specify a folder without access privileges, the application will not start up. 																		
02	The application does not start.	<ul style="list-style-type: none"> Confirm the security and firewall settings of your computer. After uninstalling, reinstall and reconfirm. 																		
03	The language displayed is English, even though I set a different language from [Language settings].	<ul style="list-style-type: none"> The language file may be corrupted. Quit and restart the program. If the issue persists, uninstall and reinstall the software. The fonts required to display the language may not be installed on your computer. Confirm that the fonts below are installed on your computer. <table border="1"> <thead> <tr> <th>Display language</th> <th>Font</th> </tr> </thead> <tbody> <tr> <td>Japanese</td> <td>MS UI Gothic</td> </tr> <tr> <td>English</td> <td>Arial</td> </tr> <tr> <td>Simplified Chinese</td> <td>SimSun</td> </tr> <tr> <td>Traditional Chinese</td> <td>MingLiU</td> </tr> <tr> <td>Korean</td> <td>BatangChe</td> </tr> <tr> <td>Thai</td> <td>Tahoma</td> </tr> <tr> <td>Indonesian</td> <td>Arial</td> </tr> <tr> <td>Spanish</td> <td>Arial</td> </tr> </tbody> </table>	Display language	Font	Japanese	MS UI Gothic	English	Arial	Simplified Chinese	SimSun	Traditional Chinese	MingLiU	Korean	BatangChe	Thai	Tahoma	Indonesian	Arial	Spanish	Arial
Display language	Font																			
Japanese	MS UI Gothic																			
English	Arial																			
Simplified Chinese	SimSun																			
Traditional Chinese	MingLiU																			
Korean	BatangChe																			
Thai	Tahoma																			
Indonesian	Arial																			
Spanish	Arial																			
04	WDR is not recognized.	<ul style="list-style-type: none"> Confirm that the cable is connected properly, and that power is being supplied. On the computer where you are connecting the WDR, check the security settings and firewall settings. 																		
05	The setting on the WDR IP address setting screen displays as "undefined", and the settings are not reflected.	<ul style="list-style-type: none"> Depending on the version of your Internet Explorer®, the screen may not display properly. Make sure Internet Explorer® compatibility view is enabled. 																		
06	I cannot view or edit WDR information in WDR settings.	<ul style="list-style-type: none"> Confirm that the cable is connected properly, and that power is being supplied. On the computer where you are connecting the WDR, check the security settings and firewall settings. 																		

07	When data collection is activated, the license authentication screen displays and data collection will not start.	<ul style="list-style-type: none"> A license is required to use the data collection function. Please purchase a license key.
08	In [WDT/WDR settings], no WDT units are displaying under [WDT list].	<ul style="list-style-type: none"> Click the [Refresh WDT list] button and check again after the WDT list is updated. Confirm that the WDT is properly connected.
09	I cannot view or edit WDT information in WDT settings.	<ul style="list-style-type: none"> Confirm that the WDT is connected properly, and that power is being supplied to the WDT.
10	I cannot generate CSV data, and cannot collect data.	<ul style="list-style-type: none"> Confirm that the WDR and WDT are connected properly. Confirm that the WDR from which you want to collect data is properly selected. Confirm that the CSV file destination folder is not deleted, or that the folder name has not been changed.
11	WDT information is not recorded in CSV data.	<ul style="list-style-type: none"> Confirm that the WDR and WDT are connected properly. Confirm that the power for WDT is on. If the WDT indicator light is red, there is a connection error.
12	The characters are garbled when reading CSV data with a third-party software.	<ul style="list-style-type: none"> The CSV data is saved in Unicode (UTF-8) format. Read the CSV data with UTF-8 encoding.
13	I can only select [blue] in counter settings.	<ul style="list-style-type: none"> When DIP switch 2 on WDT-4LR-Z2/WDT-5LR-Z2/WDT-6LR-Z2 is ON, the setting is fixed to blue. To use a different color, set all DIP switches OFF. The simple counter function is not supported for WDT-4LR-Z2/WDT-5LR-Z2/WDT-6LR-Z2 versions earlier than 3.06.
14	I do not see the yellow 'c' button that should be on the right side of the user name cell in [Collecting data - WDT information].	<ul style="list-style-type: none"> The 'c' button does not display when the [Do not use] option is selected in [Counter settings]. The 'c' button does not display if the model of your connected device does not support counter value functions.
15	The counter value does not output to CSV.	<ul style="list-style-type: none"> There will be no CSV output if [counter value] is not selected under [CSV file format] in [CSV file settings]. Subsequent counts are not collected after clicking [Exit]. The CSV files for [counter value] are updated once per minute (may fluctuate depending on network status), and will not update every time there is a status change on the signal tower.
16	The output CSV data does not match the CSV file format.	<ul style="list-style-type: none"> Editing CSV file format settings after CSV file output will cause discrepancies in the output CSV content.

17	After clicking [Start data collection], the counter output value shows "0".	<ul style="list-style-type: none">• When clicking [Start data collection], the counter value resets to 0. It is shown the next time the counter value is updated.
18	Value of WDT monitoring information is 0, but a different counter value is output.	<ul style="list-style-type: none">• When the WDT-4LR-Z2/WDT-5LR-Z2/WDT-6LR-Z2 unit is ON: There may be bad reception. Check the network status.• When the WDT-4LR-Z2/WDT-5LR-Z2/WDT-6LR-Z2 unit is OFF: The counter value from the previous session is retained until the unit turns back ON.
19	The CSV file's signal tower information is fixed as 0.	<ul style="list-style-type: none">• The signal tower information defined in the counter settings is not sent, regardless of changes in status.• For information, refer to  section 9.1.1.5 in the "[WDT- □ LR-Z2/WDR-L(E)-Z2-PRO(-L) Instruction Manual]".

9.2 Error messages

Number	Message	Checklist
01	It is already running.	<ul style="list-style-type: none"> You cannot run multiple instances of this product. Exit the application before starting it again.
02	Application error has occurred.	<ul style="list-style-type: none"> An error of unknown origin may have occurred. Close this product and try restarting.
03	Initialization failure occurred.	<ul style="list-style-type: none"> An internal processing error may have occurred. Close and restart the program. If the error persists, re-install this software.
04	Error occurred in the exit process.	<ul style="list-style-type: none"> This product may not have closed properly. If the error appears frequently, re-install this product.
05	Error occurred in setting the language.	<ul style="list-style-type: none"> The language file may be damaged. Close this product and try restarting. If the error persists, re-install this software.
06	Failed to establish WDR connection.	<ul style="list-style-type: none"> Confirm that the WDR is connected properly.
07	Unable to identify COM port.	<ul style="list-style-type: none"> Confirm that the WDR is recognized by the computer.
08	Failed to coordinate with WDT.	<ul style="list-style-type: none"> Communication with the WDT may not have completed properly. Try running the command again.
09	Error occurred in setting the WDR.	<ul style="list-style-type: none"> Communication with the WDR may not have completed properly. Try running the command again.
10	Failed to get WDT information.	<ul style="list-style-type: none"> Communication with the WDT may not have completed properly. Try running the command again.
11	Error occurred in setting the WDT.	<ul style="list-style-type: none"> Communication with the WDT may not have completed properly. Try running the command again.
12	Failed to get operation setting data.	<ul style="list-style-type: none"> Internal data may be corrupted. Restart this product, and if the error persists, re-install this software.
13	Failed to import operation setting data.	<ul style="list-style-type: none"> The defined file may be corrupted. Select a valid file (.wds).
14	Failed to export operation setting data.	<ul style="list-style-type: none"> The export destination may not have been selected properly. Confirm that external media, system administration folders, or other protected folders have not been selected.

Number	Message	Checklist
15	Some of the operation settings are incomplete.	<ul style="list-style-type: none">• Operation settings are not set up correctly. Try running setup again. Refer to  section 6.2.8.
16	Failed to save operation setting data.	<ul style="list-style-type: none">• Internal data may be corrupted. Restart this product, and if the error persists, re-install this software.
17	Failed to import .init file.	<ul style="list-style-type: none">• The defined file may be corrupted. Select a valid file (.init).• The .init file may have duplicated MAC addresses. Remove any duplicated MAC addresses from the file.
18	Failed to save output data.	<ul style="list-style-type: none">• The CSV file destination folder may not be selected properly or the defined folder may not exist. Confirm the CSV file destination. Confirm that external media or system administration folders have not been selected.

PATLITE Corporation G2J

PATLITE Corporation ※Head office	■ www.patlite.com/
PATLITE (U.S.A.) Corporation	■ www.patlite.com/
PATLITE Europe GmbH ※Germany	■ www.patlite.eu/
PATLITE (SINGAPORE) PTE LTD	■ www.patlite-ap.com/
PATLITE (CHINA) Corporation	■ www.patlite.cn/
PATLITE KOREA CO., LTD.	■ www.patlite.co.kr/
PATLITE TAIWAN CO., LTD.	■ www.patlite.tw/
PATLITE (THAILAND) CO., LTD.	■ www.patlite.co.th/
PATLITE MEXICO S.A. de C.V.	■ www.patlite.com.mx/